

Muuntoyhde

RCU



Tuotekuvaus

Syvävedetty keskeismuuntoyhde 45 ° kulmalla. Lyhyt rakenepituus, pieni painehäviö ja pieni oma äänenmuodostus.

Mitat

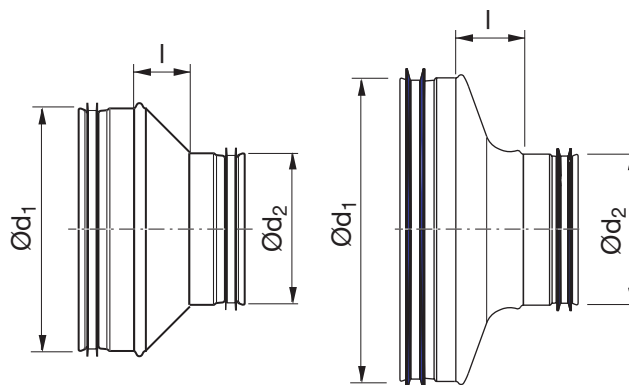

Ød ₁ nom	Ød ₂ nom	l mm	m kg
80	63	18	0,12
100	63	30	0,17
100 *	80	26	0,18
125 *	80	36	0,16
125 *	100	27	0,21
160	80	55	0,31
160 *	100	46	0,17
160 *	125	35	0,22
200 *	100	46	0,22
200 *	125	55	0,30
200 *	160	39	0,29
250	125	70	0,62
250 *	160	60	0,46
250 *	200	42	0,46
315	160	91	0,86
315 *	200	74	0,72
315 *	250	50	0,65
400	200	118	1,37
400	250	94	1,38
400	315	54	1,29
500 **	250	128	2,30
500	315	95	1,90
500	400	68	1,76
630 **	315	160	3,37
630 **	400	118	3,17
630 **	500	68	2,89

* Pyörästetyllä liitoksella

** Käsitönnä rakennettu

Tilauseimerkki

	RCU	315	250
Tuotetunnus	_____		
Mitta Ød ₁	_____		
Mitta Ød ₂	_____		



Muuntoyhde

RCU, RCFU

Tekniset tiedot

1 dimensiojako

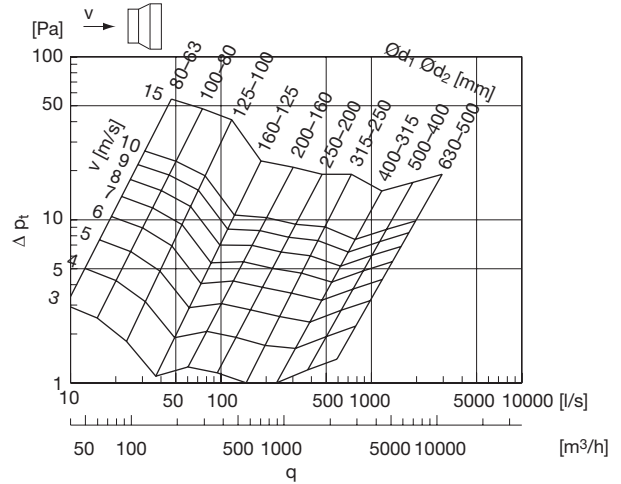
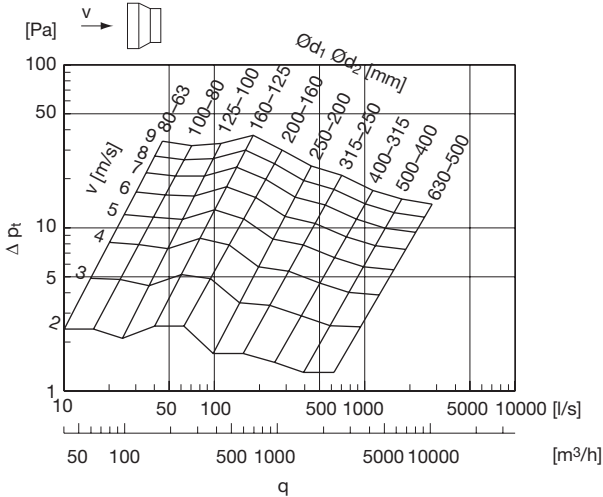

2 dimensiojako

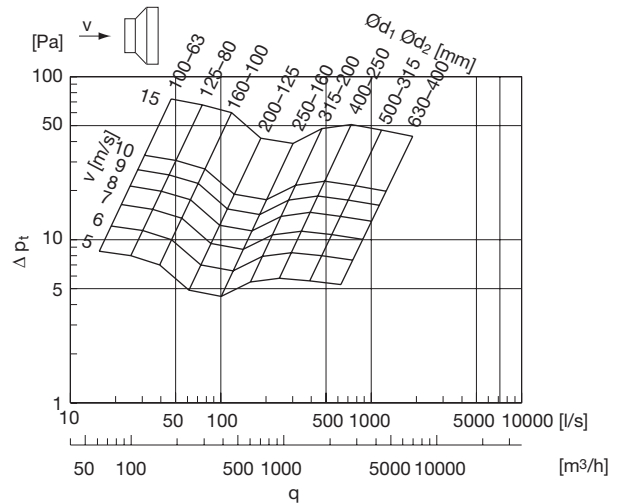
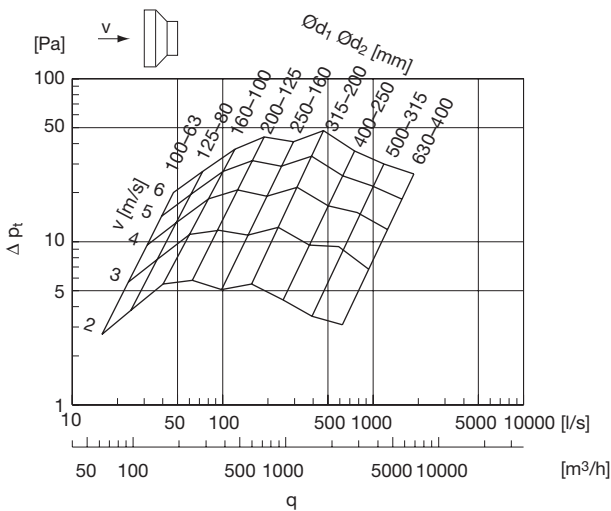

3 dimensiojako

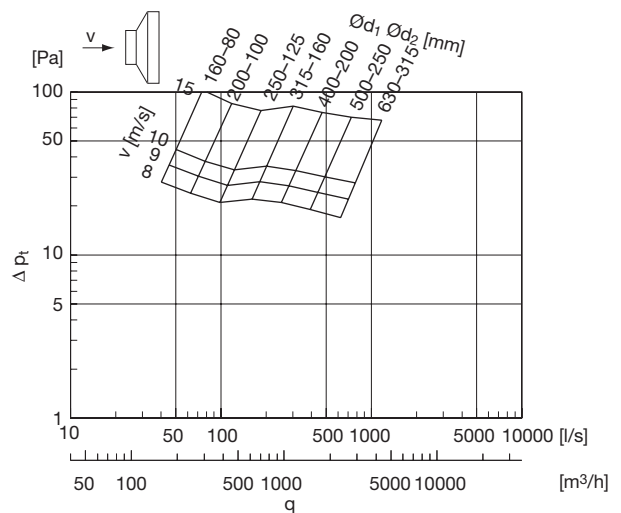
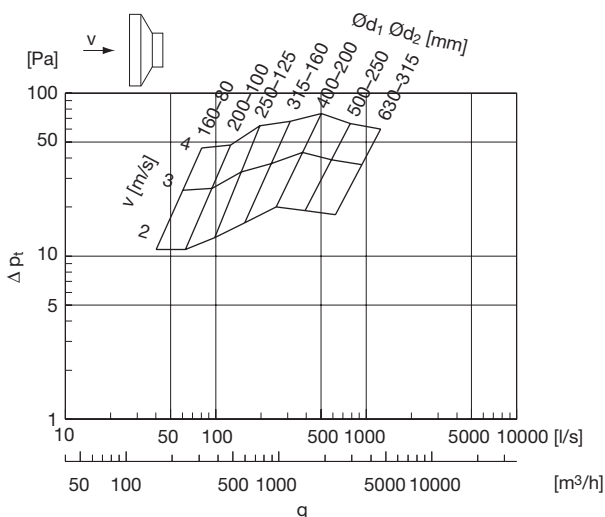

- 1
- 2
- 3
- 4
- 5
- 6
- 7
- 8
- 9
- 10
- 11
- 12
- 13
- 14
- 15
- 16
- 17
- 18