

**S-LA/130164**

Landshut, 20/03/2014  
0871 608-0  
Er/Km

**Type testing Test  
report No. 1**

Object: NEVORGA Plexus reinforcement connection

Client: NEVOGAGmbH  
Znaimer Str. 4  
83395 Freilassing

Creator of the static documents:  
Fritsche Ingenieure Ingenieurbüro  
für Bauwesen Western  
Stadtgraben 30b 94469  
Deggendorf

Period of validity: **until 31/03/2019**

The Nevoga Plexus reinforcements as types were tested for stability on the basis of the documents listed under point 1.

## 1 Test documentation

### 1.1 Verified records:

1.1.1 Static calculation: 131 pages

1.1.2 27 load tables and 3 pages description of the construction.

### 1.2. Other documents:

1.2.1 Test certificate with test report no. M1299/2 dated 17.04.2009:

Test on protective boxes ( shearing tests ) acc. to DBV data sheet" "Reverse bending of reinforcing steel and requirements for protective boxes"

### 1.3 Basic documents:

The valid technical rules, in particular:

**DIN 1045-2** 2008 - 08 Structures made of concrete, reinforced concrete and prestressed  
Part 2: concrete; definition, properties, manufacture and conformity - application rules  
**for DIN EN 206-1**

DIN 1045-3 2012 - 03 Structures made of concrete, reinforced concrete and prestressed concrete -  
Part 3: Construction -Application rules for  
**DIN EN 13670**

DIN 488 -1 2009 - 08 Reinforcing steel - Part 1: Steel grades, properties, Marking/Labeling

DIN EN 206-1 2001 - 07 Concrete - Part 1: Definition, properties, Manufacture and conformity

DIN EN 13670 2011 - 03 Execution of concrete structures

DIN EN 1992 - 1 - 1 2011 - 01 Eurocode 2: Dimensioning and construction of reinforced concrete and prestressed concrete structures - Part 1 - 1:  
General design rules and rules for the Structural engineering

DIN EN 1992 - 1 - 1/NA 2013-04 National fixed parameters - Eurocode 2:  
Design and construction of reinforced and prestressed concrete structures - Part 1 - 1:  
General design rules and rules for structural engineering

DBV data sheet Reverse bending of reinforcing steel and requirements for protective boxes according to Eurocode 2:  
Version January 2011

## **2 Description of the design**

The Nevoga Plexus reinforcement connections are prefabricated elements for producing pull-out joints and anchorage reinforcements at concreting section boundaries.

The reinforcement connection consists of a protective box made of sheet steel in which a reinforcement made of BST 500 S with diameters of 8 to 12 mm is located at different intervals.

The connecting bars in the protective boxes are first bent so that the formwork of the first concreting section is not penetrated. After striking the first section, the connecting bars are bent back to their nominal position using a suitable tool.

When using protective boxes at construction joints, the steel back part of the protective box remains in the component. The shearing force transfer is reduced at this point compared to a homogeneous construction section.

The verifications of the shearing force transfer are carried out according to the formulas of the DBV data sheet "Reverse bending of reinforcing steel and requirements for protective boxes" in connection with EC2 (DIN EN 1992).

The required roughness coefficients of the composite joint have been verified by tests conducted by RWTH.

The use of the rebend connections is limited to predominantly static loads. The load tables of the type calculations do not take stress perpendicular to the joint into account. They are possible as long as they do not cause separation cracking. However, the necessary verifications must be carried out separately.

For the tables, good bonding of the reinforcement is assumed as standard..

The same bar diameters are assumed for the calculation of the pull-out lengths.

The same bar diameters are assumed for the calculation of the overlap lengths.

DIN EN 1992-1-1, clause 8.7 with DIN 1992-1-1/NA must be observed when planning and executing the reinforcement joints.

In the case of different concrete qualities in the concreting sections, the lower concrete strength is decisive.

For construction work, reference is also made to the information in the DBV data sheet.

## **3 Construction materials**

3.1 Concrete of strength class C 20/25, C 25/30, C 30/37

3.2 Reinforcing steel BSt 500

#### **4 Test result**

The documents listed under item 1.1 were examined with regard to stability, but not with regard to other building regulations or other official requirements. They comply with the currently valid technical building regulations.

There are no structural design concerns with regard to the execution according to the tested documents; the following notes and regulations must be observed.

#### **5 Special notes**

- 5.1 The type test comprises the static proofs of the Nevoga Plexus reinforcement connections for shear force resistance according to the case distinctions a to f according to the DBV data sheet "Reverse bending according to Eurocode 2".

The type testing of cases a and b refers to the transverse force resistances along the concrete joint.

The type test of cases c to f refers to the transverse force resistances transverse to the concrete joint.

- 5.2 If bending moments are transmitted in addition to the transverse halves, separate verifications may be required.
- 5.3 When determining overlap lengths, the reduced load carrying capacity of the rebend reinforcement bars in accordance with DIN EN 1992-1-1/NA, NCI to 8.3 must be taken into account.
- 5.4 The use of the type-tested table values is limited to predominantly static loads.
- 5.5 In Case c according to the DBV data sheet "Reverse bending according to Eurocode 2" it must be noted that in the wall up to  $h_A 2: 10 \times t$  (t corresponds to the respective depth of the protective box) no concrete joint may lie below the protective box.
- 5.6 For cases b and f according to DBV data sheet "Reverse bending according to Eurocode 2", the concrete joint between the protective boxes must be smooth or rough. Very smooth concrete surfaces are not permitted.

#### **6 Documents required for the building application in individual cases**

- 6.1 Present test report no. 1, S-LA/130164 dated 19.03.2014
- 6.2 Load tables of the Nevoga Plexus reinforcement connections according to section 1.1.2

## **7 General provisions**

- 7.1 The static type test does not replace a building permit that may be required or any other public-law permits that may be required for the execution of construction projects.
- 7.2 This static type test relieves the user of the obligation to check the conformity with the prerequisites and application limits of the type test in individual cases.
- 7.3 The tested documents may only be used or published in the original version approved by the testing authority. In the event of doubt, the documents examined at the Testing Office for Structural Analysis shall be decisive.
- 7.4 The period of validity of this type test can be extended by 5 years on request.

The processor:



Dipl.-Ing. Robert Ebner

Manager:



Dipl.-Ing . Reinheid Theisz  
Ltd. Head of Construction

Non-certified translation from the German original.

Fritsche Ingenieure  
Bauwesen

Ingenieurbüro for

Deggendorf

Duplicate

Static calculation

Part 1

Load capacity calculation for NEVOGA PLEXUS reinforcement connections

Client: NEVOGA GmbH  
Znaimerstr. 4  
83395 Freilassing

Operator: Fritsche Ingenieure

Ingenieurbüro for Bauwesen

Deggendorf

Extended to 31/03/2024

Visa

See test report S-LA 130164 dated 04/02/2019 Westl. Stadtgraben 30 b 94469 Deggendorf

LGA Prüfamnt für Standsicherheit  
der Zweigstelle Landshut

Landshut, 04/02/2019

Deggendorf, 19/08/2013

The processor

Manager

Dipl. Ing. Stefan Hentschinski

Tester Valid until 31/03/2019  
Type test  
Tested with regard to stability

See test report S-LA 130 164 of 20/03/2014

LGA Prüfamnt für Standsicherheit  
der Zweigstelle Landshut

Landshut, 04/02/2019

Deggendorf, 19/08/2013

The processor

Manager

Author	Fritsche	Ingenieurbüro	
Program:	Ingenieure	für Bauwesen	
Building structure : NEVOGA Plexus reinforcement connection			Date 08/2013

**Non-certified translation from the German original.**

Table of contents	
Part 1 Static calculation	Page
1. Description of the design.....	2
2. Technical documents, test certificates, blueprints.....	3
3. Calculation of the anchorage and pull-out lengths.....	10
4. Type assignment.....	15
5. Calculation of shearing force that can be absorbed Case a.....	18
6. Calculation of shearing force that can be absorbed Case b.....	37
7. Calculation of shearing force that can be absorbed Case c.....	50
8. Calculation of shearing force that can be absorbed Case d.....	87
9. Calculation of shearing force that can be absorbed Case e.....	37
10. Calculation of shearing force that can be absorbed Case f.....	18
Part 2 Load tables	Page
	1-29
<div style="border: 1px solid black; padding: 5px; width: fit-content; margin: 0 auto;">Prüfamt für Standsicherheit <b>LGA</b> Zweigstelle Landshut S-LA of</div>	
Component: Load capacity calculation EC 2 Block: according to DBV data sheet 01/2011 page: 1 ..... Process:	ARCHIVE NO.:

**Non-certified translation from the German original.**

Author Fritsche Ingenieurbüro Program: Ingenieure für Bauwesen	
Building structure : NEVOGA Plexus reinforcement connection	Date 08/2013
<p>NEVOGA Plexus reinforcement connections are prefabricated elements for the production of lap joints as well as anchoring of reinforcements at concreting section boundaries.</p> <p>The reinforcement connection consists of a protective box made of sheet steel in which a reinforcement made of reinforcing steel B500 with diameters of 8, 10 or 12 mm is located at different distances.</p> <p>The connecting rods in the boxes are first bent so that the formwork of the first concreting section is not penetrated. After striking the first section, the connecting rods are bent back to their nominal position using a suitable tool.</p> <p>With protective boxes, the steel back part of the protective box remains in the component at the construction joints. The shearing force transfer is reduced at these points compared to a homogeneous concrete cross-section.</p> <p>The verification of the shearing force transfer is therefore carried out in the following in accordance with the specifications of the DBV data sheet "Reverse Bending of Reinforcing Steel and Requirements for Safe Cases" in conjunction with EC 2 (DIN EN 1992).</p> <p>The roughness values required for this were verified by means of tests at the Institute for Structural Research in Aachen, RWTH. The tests and the associated test certificate were prepared in accordance with DIN 1045-1 and the DBV data sheet version of January 2008. According to the DBV data sheet version of January 2011, these may also be used in connection with Eurocode 2.</p> <p>The use of the rebend connections is limited to predominantly static loads. The following load tables do not consider stresses perpendicular to the joint. They are possible as long as they do not cause separation cracking. The required verifications must be carried out separately by the user.</p> <p>Good reinforcement bond is assumed as standard for the load capacity tables. The calculation of the pull-out lengths is carried out under the assumption of identical bar diameters. In the case of different concrete qualities in the concreting sections, the lower concrete strength is decisive.</p>	<div data-bbox="1086 1677 1394 1832" style="border: 1px solid black; padding: 5px; text-align: center;">           Prüfamf für Standsicherheit  <b>LGA</b>            Zweigstelle Landshut            S-LA of         </div>
Component: Load capacity calculation EC 2 Block: according to DBV data sheet 01/2011 page: 2 ..... Process:	ARCHIVE NO.:



**Non-certified translation from the German original.**

Author Fritsche Ingenieurbüro Program: Ingenieure für Bauwesen	
Building structure : NEVOGA Plexus reinforcement connection	Date 08/2013
<p>For construction work, reference is also made to the information in the DBV data sheet.</p> <p>Materials:</p> <ul style="list-style-type: none"><li>- Concrete of strength classes C20/25, C25/30, C30/37 according to DIN EN 206-1 and DIN EN 1992</li><li>- Reinforcing steel B500A according to DIN 488-1</li></ul> <p><u>2. Technical documents, test certificates</u></p> <ul style="list-style-type: none"><li>- DIN EN 1992-1-1:2011-01</li><li>- DIN EN 1992-1-1/ NA 2013-04</li><li>- DIN 1045-2:2008-08</li><li>- DIN EN 206-1: 2001-07</li><li>- DIN 488-1: 2009-08</li><li>- DBV data sheet "Reverse bending of reinforcing steel and requirements for protective boxes according to Eurocode 2": 2011-01</li><li>- Technical Information NEVOGA Plexus</li><li>- Test report M 1299/2 Test on protective box of RTWH Aachen (2009-03-19)</li><li>- Factory drawings for the reverse bend connections according to NE-VOGA specification</li></ul> <div data-bbox="746 1458 1054 1615" style="border: 1px solid green; padding: 5px; text-align: center;"><p>Prüfamt für Standsicherheit <b>LGA</b> Zweigstelle Landshut</p><p>S-LA of</p></div>	
Component: Load capacity calculation EC 2 Block: according to DBV data sheet 01/2011 page: 3 ..... Process:	ARCHIVE NO.:

**Non-certified translation from the German original.**

<p>Author: Fritsche          Program: Ingenieure          Ingenieurbüro für Bauwesen</p>	
<p>Building structure : NEVOGA Plexus reinforcement connection</p>	
<p>Date 08/2013</p>	
<p style="text-align: center;">Type A Top view</p> <p style="text-align: right;">M:15</p> <div style="border: 1px solid green; padding: 5px; width: fit-content; margin-bottom: 10px;"> <p> <math>\varnothing 8 \text{ mm} = 80 \text{ mm}</math>  <math>\varnothing 10 \text{ mm} = 100 \text{ mm}</math>  <math>\varnothing 12 \text{ mm} = 120 \text{ mm}</math> </p> </div> <p style="text-align: center;">View</p> <div style="border: 1px solid green; padding: 5px; margin-bottom: 10px;"> <p> <math>\varnothing 8 \text{ mm } H = 150 \text{ mm}</math>  <math>\varnothing 10 \text{ mm } H = 150 \text{ mm}</math>  <math>\varnothing 12 \text{ mm } H = 170 \text{ mm}</math> </p> </div> <div style="border: 1px solid green; padding: 5px; margin-bottom: 10px;"> <p> <math>\varnothing 8 \text{ mm } B = 50 \text{ mm}</math>  <math>\varnothing 10 \text{ mm } B = 60 \text{ mm}</math>  <math>\varnothing 12 \text{ mm } B = 75 \text{ mm}</math> </p> </div> <div style="border: 1px solid green; padding: 5px; margin-bottom: 10px;"> <p> <math>\varnothing 8 \text{ mm } l_s = 320 \text{ mm}</math>  <math>\varnothing 10 \text{ mm } l_s = 390 \text{ mm}</math>  <math>\varnothing 12 \text{ mm } l_s = 460 \text{ mm}</math> </p> </div> <div style="border: 1px solid green; padding: 5px;"> <p style="text-align: center;">Prüfamt für Standsicherheit  <b>LGA</b>          Zweigstelle Landshut</p> <p>S-LA of</p> </div>	
<p>Component: Load capacity calculation EC 2          Block: according to DBV data sheet 01/2011 page: 4          .....          Process:</p>	<p>ARCHIVE NO.:</p>

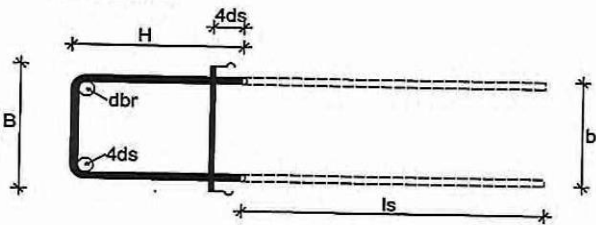
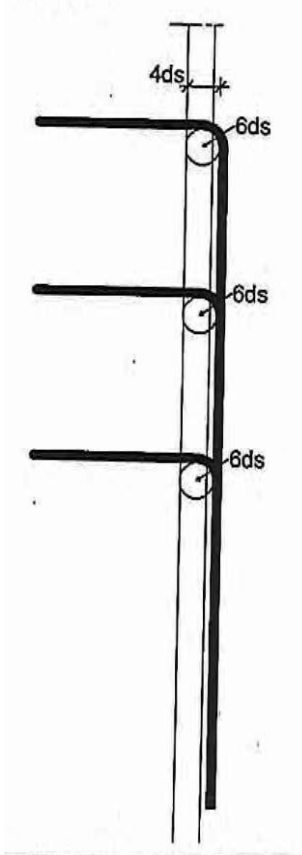
Author Program:	Fritsche Ingenieure	Ingenieurbüro für Bauwesen	
Building structure : NEVOGA Plexus reinforcement connection		Date 08/2013	
<p>Type B <span style="float: right;">M:15</span></p> <p style="text-align: center;">Top view</p>  <p style="text-align: center;">View</p>  <div style="border: 1px solid green; padding: 5px; width: fit-content; margin: 5px;">       B= 85 mm   b= 60 mm        B= 115 mm   b= 90 mm        B= 145 mm   b= 120 mm        B= 175 mm   b= 150 mm        B= 205 mm   b= 180 mm        B= 225 mm   b= 200 mm     </div> <div style="border: 1px solid green; padding: 5px; width: fit-content; margin: 5px;">       Ø 8 mm   ls = 320 mm        Ø 10 mm   ls = 390 mm        Ø 12 mm   ls = 460 mm     </div> <div style="border: 1px solid green; padding: 5px; width: fit-content; margin: 5px;">       Ø 8 mm   H = 150 mm        Ø 10 mm   H = 150 mm        Ø 12 mm   H = 170 mm     </div> <div style="border: 1px solid green; padding: 5px; width: fit-content; margin: 5px;">       Prüfamt für Standsicherheit  <b>LGA</b>        Zweigstelle Landshut        S-LA <span style="float: right;">of</span> </div>			
Component: Load capacity calculation EC 2 Block: according to DBV data sheet 01/2011 page: 5 ..... Process:		ARCHIVE NO.:	

**Non-certified translation from the German original.**

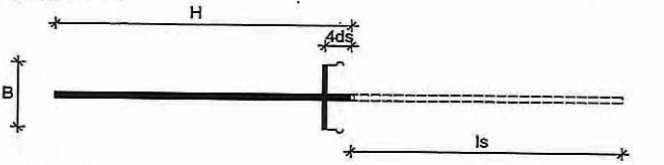
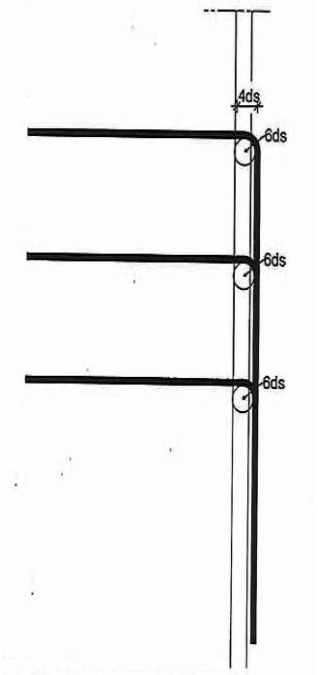
<p>Author: Fritsche          Program: Ingenieure          Ingenieurbüro für Bauwesen</p>	
<p>Building structure : NEVOGA Plexus reinforcement connection</p>	
<p>Date 08/2013</p>	
<p style="text-align: center;">Type D <span style="float: right;">M:15</span>          Top view</p>  <p style="text-align: center;">View</p>  <div style="display: flex; flex-direction: column; align-items: flex-start;"> <div style="border: 1px solid green; padding: 5px; margin-bottom: 10px;"> <p>∅ 8 mm ls = 320 mm              ∅ 10 mm ls = 390 mm              ∅ 12 mm ls = 460 mm</p> </div> <div style="border: 1px solid green; padding: 5px; margin-bottom: 10px;"> <p>∅ 8 mm H = 350 mm              ∅ 10 mm H = 430 mm              ∅ 12 mm H = 510 mm</p> </div> <div style="border: 1px solid green; padding: 5px; margin-bottom: 10px;"> <p>∅ 8 mm B = 50 mm              ∅ 10 mm B = 60 mm              ∅ 12 mm B = 75 mm</p> </div> <div style="border: 1px solid green; padding: 5px; width: 100%;"> <p style="text-align: center;">Prüfamt für Standsicherheit  <b>LGA</b>              Zweigstelle Landshut</p> <p>S-LA <span style="float: right;">of</span></p> </div> </div>	
<p>Component: Load capacity calculation EC 2          Block: according to DBV data sheet 01/2011 page: 6          .....</p>	<p>ARCHIVE NO.:</p>
<p>Process:</p>	

**Non-certified translation from the German original.**

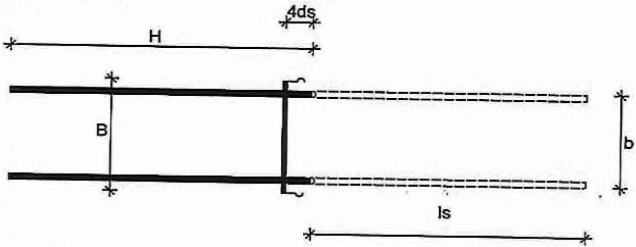
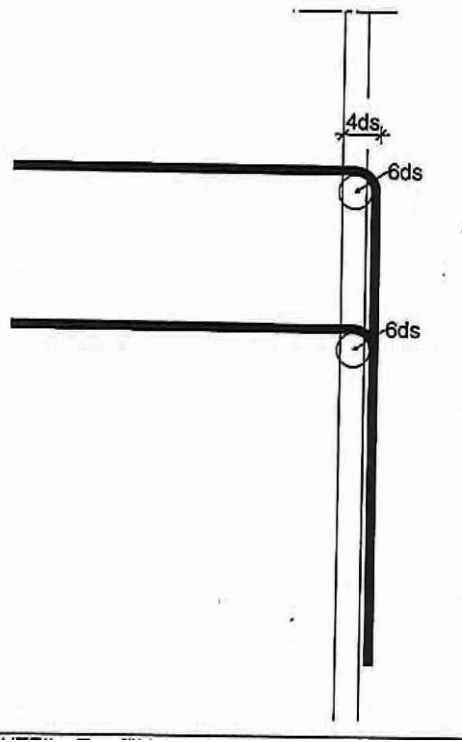
<p>Author: Fritsche          Program: Ingenieure          Ingenieurbüro für Bauwesen</p>	
<p>Building structure : NEVOGA Plexus reinforcement connection</p>	<p>Date 08/2013</p>
<p>Type DD M:15</p> <p>Top view</p>  <p>View</p>  <div data-bbox="692 775 1040 1010" style="border: 1px solid green; padding: 5px;"> <p>B= 85 mm b= 60 mm              B= 115 mm b= 90 mm              B= 145 mm b= 120 mm              B= 175 mm b= 150 mm              B= 205 mm b= 180 mm              B= 225 mm b= 200 mm</p> </div> <div data-bbox="692 1028 1040 1173" style="border: 1px solid green; padding: 5px;"> <p>Ø 8 mm ls = 320 mm              Ø 10 mm ls = 390 mm              Ø 12 mm ls = 460 mm</p> </div> <div data-bbox="692 1189 1040 1317" style="border: 1px solid green; padding: 5px;"> <p>Ø 8 mm H = 350 mm              Ø 10 mm H = 430 mm              Ø 12 mm H = 510 mm</p> </div> <div data-bbox="699 1424 987 1585" style="border: 1px solid green; padding: 5px;"> <p>Prüfamt für Standsicherheit  <b>LGA</b>              Zweigstelle Landshut              S-LA of</p> </div>	
<p>Component: Load capacity calculation EC 2          Block: according to DBV data sheet 01/2011 page: 7          .....</p>	<p>ARCHIVE NO.:</p>
<p>Process:</p>	

**Non-certified translation from the German original.**

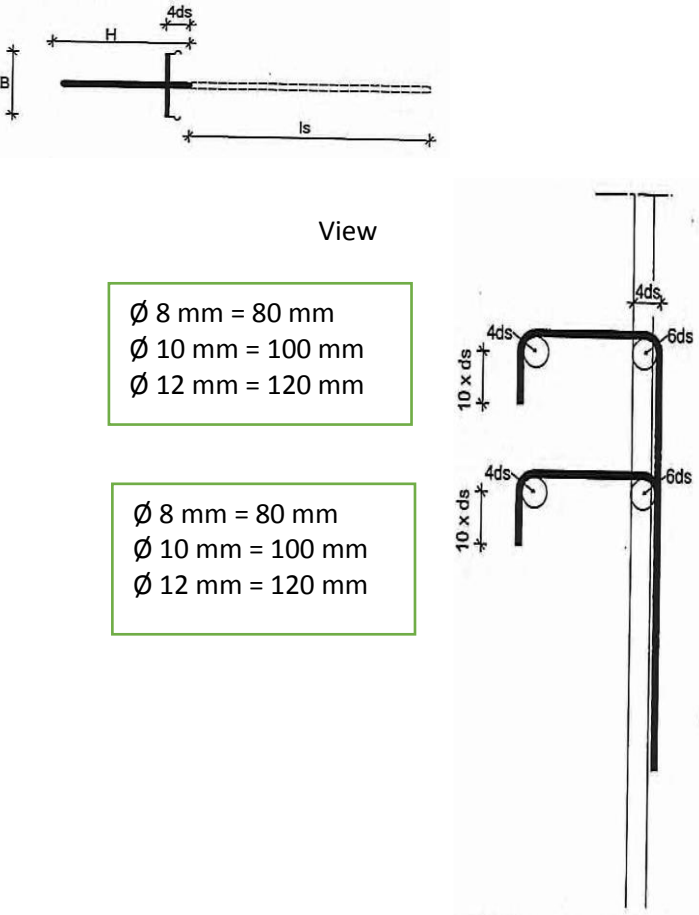
<p>Author Program:</p>	<p>Fritsche Ingenieure</p>	<p>Ingenieurbüro für Bauwesen</p>	
<p>Building structure : NEVOGA Plexus reinforcement connection</p>			<p>Date 08/2013</p>
<p style="text-align: center;">Type I Top view</p>  <div style="display: flex; justify-content: space-around; margin-top: 20px;"> <div data-bbox="325 698 630 844" style="border: 1px solid green; padding: 5px;"> <p>Ø 8 mm = 80 mm Ø 10 mm = 100 mm Ø 12 mm = 120 mm</p> </div> <div data-bbox="325 904 630 1050" style="border: 1px solid green; padding: 5px;"> <p>Ø 8 mm = 80 mm Ø 10 mm = 100 mm Ø 12 mm = 120 mm</p> </div> <div data-bbox="938 685 1244 817" style="border: 1px solid green; padding: 5px;"> <p>Ø 8 mm H= 150 mm Ø 10 mm H= 150 mm Ø 12 mm H= 170 mm</p> </div> <div data-bbox="938 819 1244 952" style="border: 1px solid green; padding: 5px;"> <p>Ø 8 mm B= 50 mm Ø 10 mm B= 60 mm Ø 12 mm B= 75 mm</p> </div> <div data-bbox="938 954 1244 1086" style="border: 1px solid green; padding: 5px;"> <p>Ø 8 mm ls = 320 mm Ø 10 mm ls = 390 mm Ø 12 mm ls = 460 mm</p> </div> </div> <div data-bbox="1032 1169 1319 1330" style="border: 1px solid green; padding: 5px; margin-top: 20px;"> <p>Prüfamt für Standsicherheit <b>LGA</b> Zweigstelle Landshut S-LA of</p> </div>			<p style="text-align: right;">M:15</p>
<p>Component: Load capacity calculation EC 2 Block: according to DBV data sheet 01/2011 page: 8 ..... Process:</p>			<p>ARCHIVE NO.:</p>

**Non-certified translation from the German original.**

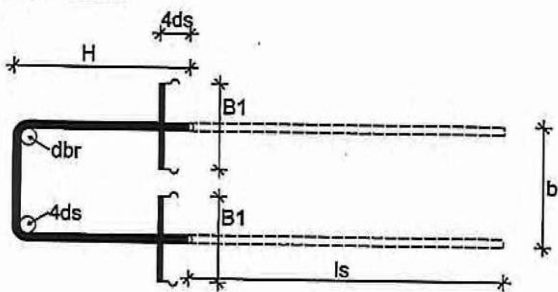
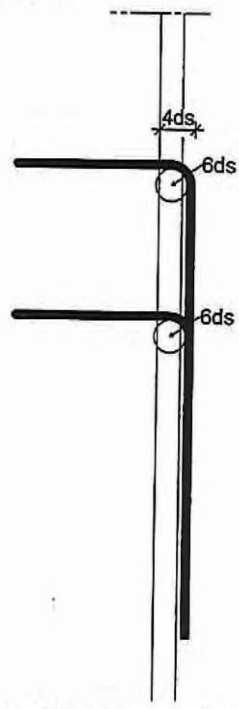
<p>Author: Fritsche          Program: Ingenieure          Ingenieurbüro für Bauwesen</p>	
<p>Building structure : NEVOGA Plexus reinforcement connection</p>	
<p>Date 08/2013</p>	
<p style="text-align: center;">Type M <span style="float: right;">M:15</span>          Top view</p>  <p style="text-align: center;">View</p>  <div style="display: flex; flex-direction: column; align-items: center;"> <div style="border: 1px solid green; padding: 5px; margin-bottom: 10px;"> <p>Ø 8 mm <math>l_s = 320</math> mm              Ø 10 mm <math>l_s = 390</math> mm              Ø 12 mm <math>l_s = 460</math> mm</p> </div> <div style="border: 1px solid green; padding: 5px; margin-bottom: 10px;"> <p>Ø 8 mm <math>H = 150</math> mm              Ø 10 mm <math>H = 150</math> mm              Ø 12 mm <math>H = 170</math> mm</p> </div> <div style="border: 1px solid green; padding: 5px; margin-bottom: 10px;"> <p>Ø 8 mm <math>B1 = 50</math> mm              Ø 10 mm <math>B1 = 60</math> mm              Ø 12 mm <math>B1 = 75</math> mm</p> </div> <div style="border: 1px solid green; padding: 5px; width: 100%;"> <p style="text-align: center;">Prüfamt für Standsicherheit  <b>LGA</b>              Zweigstelle Landshut</p> <p>S-LA <span style="float: right;">of</span></p> </div> </div>	
<p>Component: Load capacity calculation EC 2          Block: according to DBV data sheet 01/2011 page: 9          .....          Process:</p>	<p>ARCHIVE NO.:</p>

**Non-certified translation from the German original.**

Author            Fritsche                                    Ingenieurbüro Program:            Ingenieure                                    für Bauwesen	
Building structure : NEVOGA Plexus reinforcement connection	Date 08/2013
3. <u>Calculation of the anchorage and pull-out lengths</u>	
<div style="border: 1px solid green; padding: 5px; width: fit-content; margin: 0 auto;"><p>Prüfamf für Standsicherheit <b>LGA</b> Zweigstelle Landshut S-LA                                    of</p></div>	
Component: Load capacity calculation EC 2 Block:      according to DBV data sheet 01/2011 page: 10 ..... Process:	ARCHIVE NO.:



**Preliminary remarks:**

The following calculations are carried out on the basis of the currently applicable standards and regulations as well as the existing shear tests of Aachen Technical University (RWTH).

- EC 2
- DBV data sheet "Reverse bending of reinforcing steel and requirements for storage boxes" (version 2011\*01)
- Test report no. M1299/2 of 19.03.2009 of RWTH Aachen University

**1. Calculation of pull-out bar lengths**

$$L_{b,eq,dir.} = \frac{2}{3} \times \alpha_1 \times \frac{\phi}{4} \times \frac{f_{y,d,red}}{f_{bd}} \times \frac{A_{s,erf}}{A_{s,vorh.}}$$

$$L_{b,eq,dir.} = \alpha_1 \times \frac{\phi}{4} \times \frac{f_{y,d,red}}{f_{bd}} \times \frac{A_{s,erf}}{A_{s,vorh.}}$$

Compound stress B 500 depending on concrete quality

	C20 / 25	C25/30	C30/37	C35/45
F <sub>bd</sub> (VB1)	2.3	2.7	3.0	3.4
F <sub>bd</sub> (VB2)	1.6	1.9	2.1	2.4

Prüfamt für Standsicherheit  
**LGA**  
Zweigstelle Landshut  
S-LA of

Rec. pull-out bar lengths in construction section 1 for direct mounting (VB I)  $\alpha_1 = 0.70$   
For angle hook or loop

D [mm]	C20 / 25	C25/30	C30/37	C35/45
8	140 mm	121 mm	107 mm	96 mm
10	175 mm	151 mm	133 mm	120 mm
12	210 mm	181 mm	160 mm	144 mm

$$A_{s,erf} \times \frac{A_{s,vorh.}}{A_{s,vorh.}}$$

Rec. pull-out bar lengths in construction section 1 for anchorage in the field or direct mounting (VB I)

D [mm]	C20 / 25	C25/30	C30/37	C35/45
8	210 mm	181 mm	160 mm	144 mm
10	262 mm	226 mm	200 mm	181 mm
12	315 mm	272 mm	240 mm	217 mm

$$A_{s,erf} \times \frac{A_{s,vorh.}}{A_{s,vorh.}}$$

Rec. pull-out bar lengths in construction section 1 for direct mounting (VB II)

D [mm]	C20 / 25	C25/30	C30/37	C35/45
8	200 mm	172 mm	152 mm	138 mm
10	250 mm	215 mm	191 mm	172 mm
12	301 mm	258 mm	229 mm	206 mm

$$A_{s,erf} \times \frac{A_{s,vorh.}}{A_{s,vorh.}}$$

Rec. pull-out bar lengths in construction section 1 for anchorage in the field or direct mounting (VB II)

D [mm]	C20 / 25	C25/30	C30/37	C35/45
8	301 mm	258 mm	229 mm	206 mm
10	375 mm	322 mm	286 mm	258 mm
12	451 mm	386 mm	343 mm	310 mm

$$A_{s,erf} \times \frac{A_{s,vorh.}}{A_{s,vorh.}}$$

The user is responsible for checking the required pullout bar length for the respective situation, taking into account the existing framework conditions and the ratio of required / existing reinforcement cross-sections.

Prüfamt für Standsicherheit  
**LGA**  
Zweigstelle Landshut  
S-LA of

Rec. pull-out bar lengths in construction section 1 for direct mounting (VB I)  $\alpha_1 = 0.70$   
For angle hook or loop

D [mm]	C20/25	C25/30	C30/37	C35/45
8	200 mm	172 mm	153 mm	138 mm
10	250 mm	216 mm	191 mm	172 mm
12	300 mm	259 mm	229 mm	206 mm

$$A_{s,erf} \times \frac{A_{s,vorh.}}{A_{s,vorh.}}$$

Rec. pull-out bar lengths in construction section 1 for anchorage in the field or direct mounting (VB I)

D [mm]	C20 / 25	C25/30	C30/37	C35/45
8	300 mm	259 mm	229 mm	206 mm
10	375 mm	323 mm	286 mm	258 mm
12	450 mm	388 mm	343 mm	310 mm

$$A_{s,erf} \times \frac{A_{s,vorh.}}{A_{s,vorh.}}$$

Rec. pull-out bar lengths in construction section 1 for direct mounting (VB II)

D [mm]	C20 / 25	C25/30	C30/37	C35/45
8	286 mm	245 mm	218 mm	197 mm
10	358 mm	307 mm	272 mm	246 mm
12	429 mm	368 mm	327 mm	295 mm

$$A_{s,erf} \times \frac{A_{s,vorh.}}{A_{s,vorh.}}$$

Rec. pull-out bar lengths in construction section 1 for anchorage in the field or direct mounting (VBII)

D [mm]	C20 / 25	C25/30	C30/37	C35/45
8	429 mm	368 mm	327 mm	295 mm
10	537 mm	460 mm	408 mm	368 mm
12	644 mm	552 mm	490 mm	442 mm

$$A_{s,erf} \times \frac{A_{s,vorh.}}{A_{s,vorh.}}$$

The user is responsible for checking the required pullout bar length for the respective situation, taking into account the existing framework conditions and the ratio of required / existing reinforcement cross-sections.

Prüfamt für Standsicherheit  
**LGA**  
Zweigstelle Landshut  
S-LA of

2. Calculation of pull-out length

$$L_s = \alpha_6 \times \alpha_1 \times \frac{\phi}{4} \times \frac{f_{yd,red}}{f_{bd}} \times \frac{A_{s,erf}}{A_{s,vorh.}}$$

$\alpha_6 = 1.00$

for bar spacing  $a > 8 \phi$  (to be checked by the user)

for bar spacing  $c_1 > 4 \phi$  (to be checked by the user)

Edge distance to be maintained

D [mm]	C <sub>1</sub>
8	32 mm
10	40 mm
12	48 mm

Rec. pull-out lengths in construction section 2 (VB I)

D [mm]	C20 / 25	C25/30	C30/37	C35/45
8	300 mm	259 mm	229 mm	206 mm
10	375 mm	323 mm	286 mm	258 mm
12	450 mm	388 mm	343 mm	310 mm

$$\frac{A_{s,erf}}{A_{s,vorh.}}$$

Rec. pull-out lengths in construction section 2 (VB II)

D [mm]	C20 / 25	C25/30	C30/37	C35/45
8	429 mm	368 mm	327 mm	295 mm
10	537 mm	460 mm	408 mm	368 mm
12	644 mm	552 mm	490 mm	442 mm

$$\frac{A_{s,erf}}{A_{s,vorh.}}$$

The user is responsible for checking the required pullout bar length for the respective situation, taking into account the existing framework conditions and the ratio of required / existing reinforcement cross-sections.

Prüfamt für  
Standicherheit  
**LGA**  
Zweigstelle Landshut

S-LA of

**Non-certified translation from the German original.**

Author Fritsche Ingenieurbüro Program: Ingenieure für Bauwesen	
Building structure : NEVOGA Plexus reinforcement connection	Date 08/2013
4. <u>Type assignment</u>  <div data-bbox="737 943 1043 1106" style="border: 1px solid green; padding: 5px; text-align: center; margin: 20px auto; width: fit-content;">Prüfamt für Standsicherheit <b>LGA</b> Zweigstelle Landshut S-LA of</div>	
Component: Load capacity calculation EC 2 Block: according to DBV data sheet 01/2011 page: 15 ..... Process:	ARCHIVE NO.:

In the following, the various types for rebend connections are assigned to the Plexus types in accordance with the DBV data sheet "Rebending of reinforcing steel and requirements for protective boxes".

The shearing forces that can be absorbed at the concreting joint are calculated in relation to these types and shown in the following table.

A test report for shearing tests in longitudinal and transverse direction was available. In the following, the shearing force that can be absorbed for types A, B, D, DD, I and M is calculated.

These are assigned to the standard cases of the DBV data sheet Fig. 8.

DBV data sheet Figure 8 a

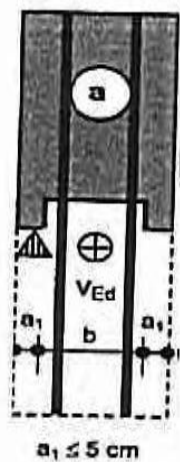

Negova Plexus

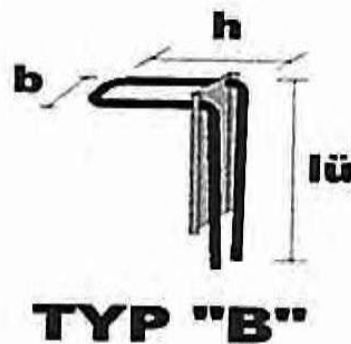

Load: Shearing force parallel

Concreting section boundary

Load: Shearing force parallel

DBV data sheet Figure 8 b

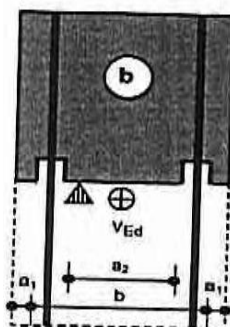

Negova Plexus

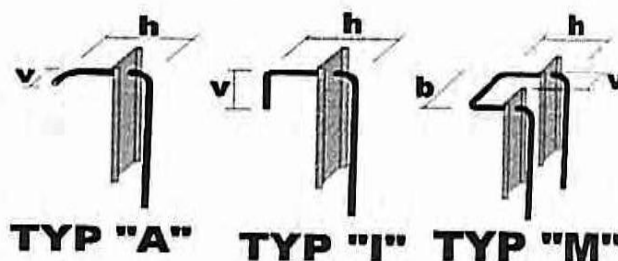

Load: Shearing force parallel

DBV data sheet Figure 8 c

Nevoga Plexus

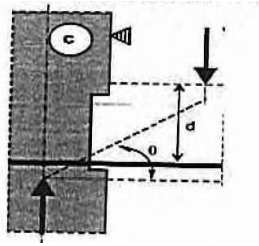

Connection wall-ceiling

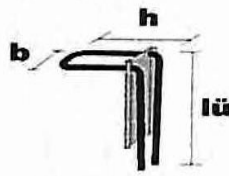

**TYP "B"**

Load: Shearing force vertical

DBV data sheet Figure 8 d

Nevoga Plexus

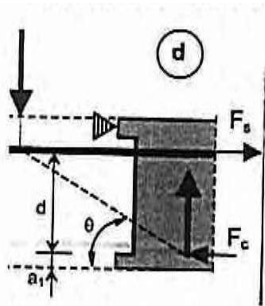

Connection wall-ceiling

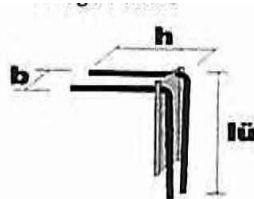

**TYP "DD"**

Load: Shearing force vertical

DBV data sheet Figure 8 e

Nevoga Plexus

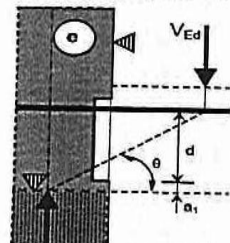

Connection wall-ceiling

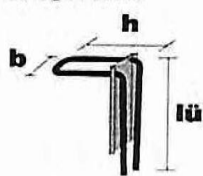

**TYP "B"**

Load: Shearing force vertical

DBV data sheet Figure 8 f

Nevoga Plexus

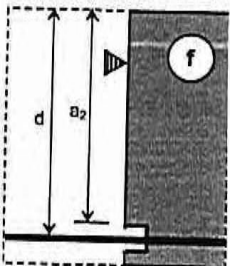

Connection wall-ceiling

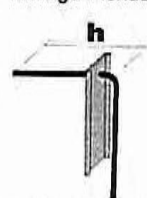

**TYP "D"**

Load: Shearing force vertical





Load tables Nevoga Plexus reinforcement connections

Absorbable shearing force lengthwise to the concrete joint (case a)

Total load-bearing capacity = load-bearing elements [concrete + friction] + reinforcement < maximum value

$$V_{Rdi} = (c \times f_{ctd} + \mu \times \sigma_n) \times b + V_{Rdi,s} \leq V_{Rdi, max}$$

$$V_{Rdi, max} = 0.5 \times v \times f_{cd} \times b$$

$$V_{Rdi, s} = a_s \times f_{y,red} \times (1.2 \times \mu \times \sin a + \cos a)$$

A<sub>s</sub> values (both rebars taken into account)

Values for direct mounting in construction section 1

Ø 8-25	3.39	3.39	3.39	3.39	3.39	3.39
Ø 8-20	4.24	4.24	4.24	4.24	4.24	4.24
Ø 8-15	5.65	5.65	5.65	5.65	5.65	5.65
Ø 8-10	8.47	8.47	8.47	8.47	8.47	8.47
Reduction	Factor l <sub>s, vorh.</sub> / l <sub>s, arf</sub>		Factor l <sub>b, dir. vorh.</sub> / l <sub>b, dir, arf</sub>			
Ø 10-25	3.95	3.95	3.95	3.95	3.95	3.95
Ø 10-20	4.94	4.94	4.94	4.94	4.94	4.94
Ø 10-15	6.58	6.58	6.58	6.58	6.58	6.58
Ø 10-10	9.88	9.88	9.88	9.88	9.88	9.88
Reduction of the A <sub>s</sub> values with the factor l <sub>b, dir, vorh.</sub> / l <sub>b, dir, arf</sub> .						
Ø 12-25	5.26	5.26	5.26	5.26	5.26	5.26
Ø 12-20	6.57	6.57	6.57	6.57	6.57	6.57
Ø 12-15	8.77	8.77	8.77	8.77	8.77	8.77
Ø 12-10	13.15	13.15	13.15	13.15	13.15	13.15
Reduction of the A <sub>s</sub> values with the factor l <sub>b, dir, vorh.</sub> / l <sub>b, dir, arf</sub> .						

Prüfamt für Standsicherheit  
**LGA**  
Zweigstelle Landshut

S-LA \_\_\_\_\_ of \_\_\_\_\_

**Non-certified translation from the German original.**

Fritsche Ingenieure

Ingenieurbüro für Bauwesen

Calculation of load capacity from concrete + friction + reinforcement direct mounting in CS 1

$F_{cirl} = 0.8 \text{ MN/m}^2$	$F_{yd} = 347.8 \text{ MN/m}_2$	$v = 0.20$
Concrete quality 20 / 25	$C = 0.20$	$\mu = 0.60$
$V_{Rd,i} \text{ [kN/m]}$		
Nevoga Plexus Type B		



Box width B	85 mm	115 mm	145 mm	175 mm	205 mm	225 mm	mm
Anchorage	h = 15 cm	h = 15 cm	h = 15 cm	h = 15 cm	h = 15 cm	h = 15 cm	Pull-out
Ø 8-25	99.06	104.06	109.96	114.06	119.06	122.40	L <sub>s</sub> = 320 mm
Ø 8-20	120.39	125.39	130.39	135.39	140.39	143.73	
Ø 8-15	155.66	160.66	165.66	170.68	175.66	178.99	
Ø 8-10	226.41	231.41	236.41	241.41	246.41	249.74	

Box width B	85 mm	115 mm	145 mm	175 mm	205 mm	225 mm	mm
Anchorage	h = 15 cm	h = 15 cm	h = 15 cm	h = 15 cm	h = 15 cm	h = 15 cm	Pull-out
Ø 10-25	113.07	118.07	123.07	128.07	133.07	136.41	L <sub>s</sub> = 390 mm
Ø 10-20	137.80	142.80	147.80	152.80	157.80	161.13	
Ø 10-15	179.06	184.06	189.06	194.06	199.06	202.40	
Ø 10-10	261.59	266.59	271.59	276.59	281.59	284.92	

Box width B	85 mm	115 mm	145 mm	175 mm	205 mm	225 mm	mm
Anchorage	h = 17 cm	h = 17 cm	h = 17 cm	h = 17 cm	h = 17 cm	h = 17 cm	Pull-out
Ø 12-25	145.90	150.90	155.90	160.90	165.90	169.23	L <sub>s</sub> = 460 mm
Ø 12-20	178.80	183.80	188.80	193.80	198.80	202.13	
Ø 12-15	233.68	238.68	243.68	248.68	253.68	257.01	
Ø 12-10	343.43	348.43	353.43	358.43	363.43	366.76	

Limitation by concrete strut (maximum value) direct mounting in CS 1

$F_{cirl} = 0.8 \text{ MN/m}^2$	$a_1 < 50 \text{ mm}$	$v = 0.20$
Concrete quality 20 / 25	$C = 0.20$	$\mu = 0.60$
$V_{Rd,i} \text{ [kN/m]}$		
Nevoga Plexus Type B		



Box width B	85 mm	115 mm	145 mm	175 mm	205 mm	225 mm	mm
Anchorage	h = 15 cm	h = 15 cm	h = 15 cm	h = 15 cm	h = 15 cm	h = 15 cm	Pull-out
Ø 8-25	96.33	130.33	164.33	198.33	232.33	255.00	L <sub>s</sub> = 320 mm
Ø 8-20	96.33	130.33	164.33	198.33	232.33	255.00	
Ø 8-15	96.33	130.33	164.33	198.33	232.33	255.00	
Ø 8-10	96.33	130.33	164.33	198.33	232.33	255.00	

Box width B	85 mm	115 mm	145 mm	175 mm	205 mm	225 mm	mm
Anchorage	h = 15 cm	h = 15 cm	h = 15 cm	h = 15 cm	h = 15 cm	h = 15 cm	Pull-out
Ø 10-25	96.33	130.33	164.33	198.33	232.33	255.00	L <sub>s</sub> = 390 mm
Ø 10-20	96.33	130.33	164.33	198.33	232.33	255.00	
Ø 10-15	96.33	130.33	164.33	198.33	232.33	255.00	
Ø 10-10	96.33	130.33	164.33	198.33	232.33	255.00	

Box width B	85 mm	115 mm	145 mm	175 mm	205 mm	225 mm	mm
Anchorage	h = 17 cm	h = 17 cm	h = 17 cm	h = 17 cm	h = 17 cm	h = 17 cm	Pull-out
Ø 12-25	96.33	130.33	164.33	198.33	232.33	255.00	L <sub>s</sub> = 460 mm
Ø 12-20	96.33	130.33	164.33	198.33	232.33	255.00	
Ø 12-15	96.33	130.33	164.33	198.33	232.33	255.00	
Ø 12-10	96.33	130.33	164.33	198.33	232.33	255.00	

am für S  
Standicherheit  
LGA  
Zweigstelle Landshut  
S-LA  
of

**Non-certified translation from the German original.**

Evaluation

Assumptions: Data sheet Reverse bending Fig. 8 a

direct mounting in CS 1

$\sigma_{cd} = () \text{ MN/m}^2$	$b_w = 1.0 \text{ m}$	$a_1 < 50 \text{ mm}$	$v = 0.20$
Concrete quality 20 / 25		$C = 0.20$	$\mu = 0.60$
$V_{Rd,i} [\text{kN/m}]$			
Nevoga Plexus Type B			

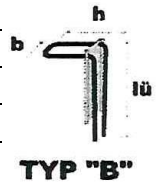

Box width B	85 mm	115 mm	145 mm	175 mm	205 mm	225 mm	mm
Anchorage	h = 15 cm	h = 15 cm	h = 15 cm	h = 15 cm	h = 15 cm	h = 15 cm	Pull-out
Ø 8-25	96.33	104.06	109.06	114.06	119.06	122.40	L <sub>s</sub> = 320 mm
Ø 8-20	96.33	125.39	130.39	135.39	140.39	143.73	
Ø 8-15	96.33	130.33	164.33	170.66	175.66	178.99	
Ø 8-10	96.33	130.33	164.33	198.33	232.33	249.74	

Box width B	85 mm	115 mm	145 mm	175 mm	205 mm	225 mm	mm
Anchorage	h = 15 cm	h = 15 cm	h = 15 cm	h = 15 cm	h = 15 cm	h = 15 cm	Pull-out
Ø 10-25	96.33	118.07	123.07	128.07	133.07	136.41	L <sub>s</sub> = 390 mm
Ø 10-20	96.33	130.33	147.80	152.80	157.80	161.13	
Ø 10-15	96.33	130.33	164.33	194.06	199.06	202.40	
Ø 10-10	96.33	130.33	164.33	198.33	232.33	255.00	

Box width B	85 mm	115 mm	145 mm	175 mm	205 mm	225 mm	mm
Anchorage	h = 17 cm	h = 17 cm	h = 17 cm	h = 17 cm	h = 17 cm	h = 17 cm	Pull-out
Ø 12-25	96.33	130.33	155.90	160.90	165.90	169.23	L <sub>s</sub> = 460 mm
Ø 12-20	96.33	130.33	164.33	193.80	198.80	202.13	
Ø 12-15	96.33	130.33	164.33	198.33	232.33	255.00	
Ø 12-10	96.33	130.33	164.33	198.33	232.33	255.00	

The verification of the pull-out lengths in construction section 2 must be carried out by the user!

The boundary conditions, whether direct or indirect mounting of construction section 1 was given, must be checked by the user!

Prüfamt für  
Standicherheit  
**LGA**  
Zweigstelle Landshut

Load tables Nevoga Plexus reinforcement connections

Absorbable shearing force lengthwise to the concrete joint (case a)

Total load-bearing capacity = load-bearing elements [concrete + friction] + reinforcement < maximum value

$$V_{Rdi} = (c \times f_{ctd} + \mu \times \sigma_n) \times b + V_{Rdi,s} \leq V_{Rdi, max}$$

$$V_{Rdi, max} = 0.5 \times v \times f_{cd} \times b$$

$$V_{Rdi, s} = a_s \times f_{yd,red} \times (1.2 \times \mu \times \sin a + \cos a)$$

A<sub>s</sub> values (both rebars taken into account)

Values for indirect mounting in construction section 1

Ø 8-25	2.26	2.26	2.26	2.26	2.26	2.26
Ø 8-20	2.83	2.83	2.83	2.83	2.83	2.83
Ø 8-15	3.77	3.77	3.77	3.77	3.77	3.77
Ø 8-10	5.65	5.65	5.65	5.65	5.65	5.65
Reduction of the A <sub>s</sub> values with the factor $l_{b,dir, vorh.} / l_{b, dir, arf.}$						
Ø 10-25	2.63	2.63	2.63	2.63	2.63	2.63
Ø 10-20	3.29	3.29	3.29	3.29	3.29	3.29
Ø 10-15	4.39	4.39	4.39	4.39	4.39	4.39
Ø 10-10	6.59	6.59	6.59	6.59	6.59	6.59
Reduction of the A <sub>s</sub> values with the factor $l_{b,dir, vorh.} / l_{b, dir, arf.}$						
Ø 12-25	3.51	3.51	3.51	3.51	3.51	3.51
Ø 12-20	4.38	4.38	4.38	4.38	4.38	4.38
Ø 12-15	5.84	5.84	5.84	5.84	5.84	5.84
Ø 12-10	8.77	8.77	8.77	8.77	8.77	8.77
Reduction of the A <sub>s</sub> values with the factor $l_{b,dir, vorh.} / l_{b, dir, arf.}$						

**Non-certified translation from the German original.**

Fritsche Ingenieure

Ingenieurbüro für Bauwesen

Calculation of load capacity from concrete + friction + reinforcement indirect mounting in CS 1

$F_{cirl} = 0.8 \text{ MN/m}^2$	$f_{yd,Rd} = 347.8 \text{ MN/M}^2$	$v = 0.20$
Concrete quality 20 / 25	$C = 0.20$	$\mu = 0.60$
$V_{Rd,i} \text{ [kN/m]}$		
Nevoga Plexus Type B		

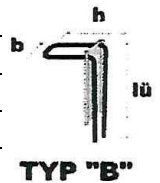

Box width B	85 mm	115 mm	145 mm	175 mm	205 mm	225 mm	mm
Anchorage	h = 15 cm	h = 15 cm	h = 15 cm	h = 15 cm	h = 15 cm	h = 15 cm	Pull-out
Ø 8-25	70.76	75.76	80.76	85.76	90.76	94.10	L <sub>s</sub> = 320 mm
Ø 8-20	84.98	89.98	94.98	99.98	104.98	108.32	
Ø 8-15	108.50	113.50	118.50	123.50	128.50	131.83	
Ø 8-10	155.66	160.66	165.66	170.66	175.66	178.99	

Box width B	85 mm	115 mm	145 mm	175 mm	205 mm	225 mm	mm
Anchorage	h = 15 cm	h = 15 cm	h = 15 cm	h = 15 cm	h = 15 cm	h = 15 cm	Pull-out
Ø 10-25	80.10	85.10	90.10	95.10	100.10	103.44	L <sub>s</sub> = 390 mm
Ø 10-20	96.59	101.59	106.59	111.59	116.59	119.92	
Ø 10-15	124.10	129.10	134.10	139.10	144.10	147.43	
Ø 10-10	179.12	184.12	189.12	194.12	199.12	202.45	

Box width B	85 mm	115 mm	145 mm	175 mm	205 mm	225 mm	mm
Anchorage	h = 17 cm	h = 17 cm	h = 17 cm	h = 17 cm	h = 17 cm	h = 17 cm	Pull-out
Ø 12-25	101.99	106.99	111.99	116.99	121.99	125.32	L <sub>s</sub> = 460 mm
Ø 12-20	123.92	128.92	133.92	138.92	143.92	147.25	
Ø 12-15	160.51	165.51	170.51	175.51	180.51	183.84	
Ø 12-10	233.68	238.88	243.68	248.68	253.68	257.01	

Limitation by concrete strut (maximum value) indirect mounting in CS 1

$F_{cirl} = 0.8 \text{ MN/m}^2$	$a_1 = < 50 \text{ mm}$	$v = 0.20$
Concrete quality 20 / 25	$C = 0.20$	$\mu = 0.60$
$V_{Rd,i,max} \text{ [kN/m]}$		
Nevoga Plexus Type B		



Box width B	85 mm	115 mm	145 mm	175 mm	205 mm	225 mm	mm
Anchorage	h = 15 cm	h = 15 cm	h = 15 cm	h = 15 cm	h = 15 cm	h = 15 cm	Pull-out
Ø 8-25	96.33	130.33	164.33	198.33	232.33	255.00	L <sub>D</sub> = 320 mm
Ø 8-20	96.33	130.33	164.33	198.33	232.33	255.00	
Ø 8-15	96.33	130.33	164.33	198.33	232.33	255.00	
Ø 8-10	96.33	130.33	164.33	198.33	232.33	255.00	

Box width B	85 mm	115 mm	145 mm	175 mm	205 mm	225 mm	mm
Anchorage	h = 15 cm	h = 15 cm	h = 15 cm	h = 15 cm	h = 15 cm	h = 15 cm	Pull-out
Ø 10-25	96.33	130.33	164.33	198.33	232.33	255.00	L <sub>D</sub> = 390 mm
Ø 10-20	96.33	130.33	164.33	198.33	232.33	255.00	
Ø 10-15	96.33	130.33	164.33	198.33	232.33	255.00	
Ø 10-10	96.33	130.33	164.33	198.33	232.33	255.00	

Box width B	85 mm	115 mm	145 mm	175 mm	205 mm	225 mm	mm
Anchorage	h = 17 cm	h = 17 cm	h = 17 cm	h = 17 cm	h = 17 cm	h = 17 cm	Pull-out
Ø 12-25	96.33	130.33	164.33	198.33	232.33	255.00	L <sub>D</sub> = 460 mm
Ø 12-20	96.33	130.33	164.33	198.33	232.33	255.00	
Ø 12-15	96.33	130.33	164.33	198.33	232.33	255.00	
Ø 12-10	96.33	130.33	164.33	198.33	232.33	255.00	

Prüfamt für Standesicherheit  
LGA  
Zweigstelle Landshut  
of

Evaluation

Assumptions Data sheet Reverse bending Fig. 8 a indirect mounting in CS 1

$\sigma_{cd} = () \text{ MN/m}^2$	$b_w = 1.0 \text{ m}$	$a_1 < 50 \text{ mm}$	$v = 0.20$
Concrete quality	20 / 25	$C = 0.20$	$\mu = 0.60$
$V_{Rd,i} [\text{kN/m}]$			
Nevoga Plexus Type B			

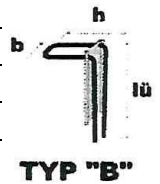

Box width B	85 mm	115 mm	145 mm	175 mm	205 mm	225 mm	mm
Anchorage	h = 15 cm	h = 15 cm	h = 15 cm	h = 15 cm	h = 15 cm	h = 15 cm	Pull-out
Ø 8-25	70.76	75.76	80.76	85.76	90.76	94.10	L <sub>s</sub> = 320 mm
Ø 8-20	84.98	89.98	94.98	99.98	104.98	108.32	
Ø 8-15	96.33	113.50	118.50	123.50	128.50	131.83	
Ø 8-10	96.33	130.33	164.33	170.66	175.66	178.99	

Box width B	85 mm	115 mm	145 mm	175 mm	205 mm	225 mm	mm
Anchorage	h = 15 cm	h = 15 cm	h = 15 cm	h = 15 cm	h = 15 cm	h = 15 cm	Pull-out
Ø 10-25	80.10	85.10	90.10	95.10	100.10	103.44	L <sub>s</sub> = 390 mm
Ø 10-20	96.33	101.59	106.59	111.59	116.59	119.92	
Ø 10-15	96.33	129.10	134.10	139.10	144.10	147.43	
Ø 10-10	96.33	130.33	164.33	194.12	199.12	202.45	

Box width B	85 mm	115 mm	145 mm	175 mm	205 mm	225 mm	mm
Anchorage	h = 17 cm	h = 17 cm	h = 17 cm	h = 17 cm	h = 17 cm	h = 17 cm	Pull-out
Ø 12-25	96.33	106.99	111.99	116.99	121.99	125.32	L <sub>s</sub> = 460 mm
Ø 12-20	96.33	128.92	133.92	138.92	143.92	147.25	
Ø 12-15	96.33	130.33	164.33	175.51	180.51	183.84	
Ø 12-10	96.33	130.33	164.33	198.33	232.33	255.00	

The verification of the pull-out lengths in construction section 2 must be carried out by the user!

The boundary conditions, whether direct or indirect mounting of construction section 1 is given, must be checked by the user!

Prüfamt für Standsicherheit  
**LGA**  
Zweigstelle Landshut  
S-LA of

Load tables Nevoga Plexus reinforcement connections

Absorbable shearing force lengthwise to the concrete joint (case a)

Total load-bearing capacity = load-bearing elements [concrete + friction] + reinforcement < maximum value

$$V_{rdi} = (c \times f_{ctd} + \mu \times \sigma_n) \times b + V_{Rdi,s} \leq V_{Rdi,max}$$

$$V_{rdi,max} = 0.5 \times v \times f_{cd} \times b$$

$$V_{rdi,s} = a_s \times f_{yd,red} \times (1.2 \times \mu \times \sin a + \cos a)$$

A<sub>s</sub> values (both rebars taken into account)

Values for direct mounting in construction section 1

Ø 8-25	3.93	3.93	3.93	3.93	3.93	3.93
Ø 8-20	4.92	4.92	4.92	4.92	4.92	4.92
Ø 8-15	6.55	6.55	6.55	6.55	6.55	6.55
Ø 8-10	9.83	9.83	9.83	9.83	9.83	9.83
Reduction	Factor l <sub>s, vorh.</sub> / l <sub>s, arf</sub>		Factor l <sub>b, dir. vorh.</sub> / l <sub>b, dir, arf</sub>			
Ø 10-25	4.58	4.58	4.58	4.58	4.58	4.58
Ø 10-20	5.72	5.72	5.72	5.72	5.72	5.72
Ø 10-15	7.63	7.63	7.63	7.63	7.63	7.63
Ø 10-10	11.46	11.46	11.46	11.46	11.46	11.46
Reduction of the A <sub>s</sub> values with the factor l <sub>b,dir, vorh.</sub> /l <sub>b, dir, arf</sub> .						
Ø 12-25	6.10	6.10	6.10	6.10	6.10	6.10
Ø 12-20	7.62	7.62	7.62	7.62	7.62	7.62
Ø 12-15	10.16	10.16	10.16	10.16	10.16	10.16
Ø 12-10	15.24	15.24	15.24	15.24	15.24	15.24
Reduction of the A <sub>s</sub> values with the factor l <sub>b,dir, vorh.</sub> /l <sub>b, dir, arf</sub> .						

Prüfamt für Standsicherheit  
**LGA**  
Zweigstelle Landshut

S-LA of

**Non-certified translation from the German original.**

Fritsche Ingenieure

Ingenieurbüro für Bauwesen

Calculation of load capacity from concrete + friction + reinforcement direct mounting in CS 1

$F_{cirl} = 1.0 \text{ MN/m}^2$	$f_{yd} = 347.8 \text{ MN/M}^2$	$v = 0.20$
Concrete quality 25 / 30	$C = 0.20$	$\mu = 0.60$
$V_{Rd,i} \text{ [kN/m]}$		
Nevoga Plexus Type B		



Box width B	85 mm	115 mm	145 mm	175 mm	205 mm	225 mm	mm
Anchorage	h = 15 cm	h = 15 cm	h = 15 cm	h = 15 cm	h = 15 cm	h = 15 cm	Pull-out
Ø 8-25	115.44	121.44	127.44	133.44	139.55	143.44	L <sub>s</sub> = 320 mm
Ø 8-20	140.17	146.17	152.17	158.17	164.17	168.17	
Ø 8-15	181.06	187.06	193.08	199.06	205.06	209.06	
Ø 8-10	263.09	269.09	275.09	281.09	287.09	291.09	

Box width B	85 mm	115 mm	145 mm	175 mm	205 mm	225 mm	mm
Anchorage	h = 15 cm	h = 15 cm	h = 15 cm	h = 15 cm	h = 15 cm	h = 15 cm	Pull-out
Ø 10-25	131.68	137.68	143.88	149.68	155.68	159.68	L <sub>s</sub> = 390 mm
Ø 10-20	160.35	166.35	172.35	178.35	184.35	188.35	
Ø 10-15	208.20	214.20	220.20	226.20	232.20	236.20	
Ø 10-10	303.88	309.88	315.88	321.88	327.88	331.88	

Box width B	85 mm	115 mm	145 mm	175 mm	205 mm	225 mm	mm
Anchorage	h = 17 cm	h = 17 cm	h = 17 cm	h = 17 cm	h = 17 cm	h = 17 cm	Pull-out
Ø 12-25	169.74	175.74	181.74	187.74	193.74	197.74	L <sub>s</sub> = 460 mm
Ø 12-20	207.89	213.89	219.89	225.89	231.89	235.89	
Ø 12-15	271.52	277.52	283.52	289.52	295.52	299.52	
Ø 12-10	398.78	404.78	410.78	416.78	422.78	426.78	

Limitation by concrete strut (maximum value) direct mounting in CS 1

$F_{cirl} = 1.0 \text{ MN/m}^2$	$a_1 < 50 \text{ mm}$	$v = 0.20$
Concrete quality 25 / 30	$C = 0.20$	$\mu = 0.60$
$V_{Rd,i,max} \text{ [kN/m]}$		
Nevoga Plexus Type B		



Box width B	85 mm	115 mm	145 mm	175 mm	205 mm	225 mm	mm
Anchorage	h = 15 cm	h = 15 cm	h = 15 cm	h = 15 cm	h = 15 cm	h = 15 cm	Pull-out
Ø 8-25	120.42	162.92	205.42	247.92	290.42	318.75	L <sub>s</sub> = 320 mm
Ø 8-20	120.42	162.92	205.42	247.92	290.42	318.75	
Ø 8-15	120.42	162.92	205.42	247.92	290.42	318.75	
Ø 8-10	120.42	162.92	205.42	247.92	290.42	318.75	

Box width B	85 mm	115 mm	145 mm	175 mm	205 mm	225 mm	mm
Anchorage	h = 15 cm	h = 15 cm	h = 15 cm	h = 15 cm	h = 15 cm	h = 15 cm	Pull-out
Ø 10-25	120.42	162.92	205.42	247.92	290.42	318.75	L <sub>s</sub> = 390 mm
Ø 10-20	120.42	162.92	205.42	247.92	290.42	318.75	
Ø 10-15	120.42	162.92	205.42	247.92	290.42	318.75	
Ø 10-10	120.42	162.92	205.42	247.92	290.42	318.75	

Box width B	85 mm	115 mm	145 mm	175 mm	205 mm	225 mm	mm
Anchorage	h = 17 cm	h = 17 cm	h = 17 cm	h = 17 cm	h = 17 cm	h = 17 cm	Pull-out
Ø 12-25	120.42	162.92	205.42	247.92	290.42	318.75	L <sub>s</sub> = 460 mm
Ø 12-20	120.42	162.92	205.42	247.92	290.42	318.75	
Ø 12-15	120.42	162.92	205.42	247.92	290.42	318.75	
Ø 12-10	120.42	162.92	205.42	247.92	290.42	318.75	

Pull-out für Standsicherheit  
 LGA  
 Zweigstelle Landshut  
 S-LA  
 of



Evaluation

Assumptions: Data sheet Reverse bending Fig. 8 a indirect mounting in CS 1

$\sigma_{cd} = () \text{ MN/m}^2$ $b_w = 1.0 \text{ m}$	$A_1 < 50 \text{ mm}$ $v = 0.20$
Concrete quality 25 / 30	$C = 0.20$ $\mu = 0.60$
$V_{Rd,i} [\text{kN/m}]$	
Nevoga Plexus Type B	



Box width B	85 mm	115 mm	145 mm	175 mm	205 mm	225 mm	mm
Anchorage	h = 15 cm	h = 15 cm	h = 15 cm	h = 15 cm	h = 15 cm	h = 15 cm	Pull-out
Ø 8-25	115.44	121.44	127.44	133.44	139.44	143.44	L <sub>s</sub> = 320 mm
Ø 8-20	120.42	146.17	152.17	158.17	164.17	168.17	
Ø 8-15	120.42	162.92	193.06	199.06	205.06	209.06	
Ø 8-10	120.42	162.92	205.42	247.92	287.09	291.09	

Box width B	85 mm	115 mm	145 mm	175 mm	205 mm	225 mm	mm
Anchorage	h = 15 cm	h = 15 cm	h = 15 cm	h = 15 cm	h = 15 cm	h = 15 cm	Pull-out
Ø 10-25	120.42	137.68	143.68	149.68	155.68	159.68	L <sub>s</sub> = 390 mm
Ø 10-20	120.42	162.92	172.35	178.35	184.25	188.35	
Ø 10-15	120.42	162.92	205.42	226.20	232.30	236.20	
Ø 10-10	120.42	162.92	205.42	247.92	290.42	318.74	

Box width B	85 mm	115 mm	145 mm	175 mm	205 mm	225 mm	mm
Anchorage	h = 17 cm	h = 17 cm	h = 17 cm	h = 17 cm	h = 17 cm	h = 17 cm	Pull-out
Ø 12-25	120.42	162.92	181.74	187.74	193.74	197.74	L <sub>s</sub> = 460 mm
Ø 12-20	120.42	162.92	205.42	225.89	231.89	235.89	
Ø 12-15	120.42	162.92	205.42	247.92	290.42	299.52	
Ø 12-10	120.42	162.92	205.42	247.92	290.42	318.75	

The verification of the pull-out lengths in construction section 2 must be carried out by the user!

The boundary conditions, whether direct or indirect mounting of construction section 1 was given, must be checked by the user!

Prüfamt für Standsicherheit  
**LGA**  
Zweigstelle Landshut

S-LA \_\_\_\_\_ of \_\_\_\_\_

Load tables Nevoga Plexus reinforcement connections

Absorbable shearing force lengthwise to the concrete joint (case a)

Total load-bearing capacity = load-bearing elements [concrete + friction] + reinforcement < maximum value

$$V_{rdi} = (c \times f_{ctd} + \mu \times \sigma_n) \times b + V_{Rdi,s} \leq V_{Rdi, max}$$

$$V_{rdi, max} = 0.5 \times v \times f_{cd} \times b$$

$$V_{rdi, s} = a_s \times f_{yd,red} \times (1.2 \times \mu \times \sin a + \cos a)$$

A<sub>s</sub> values (both rebars taken into account)

Values for indirect mounting in construction section 1

Ø 8-25	2.62	2.62	2.62	2.62	2.62	2.62
Ø 8-20	3.28	3.28	3.28	3.28	3.28	3.28
Ø 8-15	4.37	4.37	4.37	4.37	4.37	4.37
Ø 8-10	6.55	6.55	6.55	6.55	6.55	6.55
Reduction of the A <sub>s</sub> values with the factor $l_{b,Ind, vorh..} / l_{b, dir, arf.}$						
Ø 10-25	3.05	3.05	3.05	3.05	3.05	3.05
Ø 10-20	3.82	3.82	3.82	3.82	3.82	3.82
Ø 10-15	5.09	5.09	5.09	5.09	5.09	5.09
Ø 10-10	7.64	7.64	7.64	7.64	7.64	7.64
Reduction of the A <sub>s</sub> values with the factor $l_{b,Ind, vorh..} / l_{b, dir, arf.}$						
Ø 12-25	4.07	4.07	4.07	4.07	4.07	4.07
Ø 12-20	5.08	5.08	5.08	5.08	5.08	5.08
Ø 12-15	6.78	6.78	6.78	6.78	6.78	6.78
Ø 12-10	10.16	10.16	10.16	10.16	10.16	10.16
Reduction of the A <sub>s</sub> values with the factor $l_{b,Ind, vorh..} / l_{b, dir, arf.}$						

Prüfamt für Standsicherheit  
**LGA**  
Zweigstelle Landshut  
S-LA of

**Non-certified translation from the German original.**

Fritsche Ingenieure

Ingenieurbüro für Bauwesen

Calculation of load capacity from concrete + friction + reinforcement indirect mounting in CS 1

$F_{cirl} = 1.0 \text{ MN/m}^2$	$f_{yd} = 347.8 \text{ MN/M}^2$	$v = 0.20$
Concrete quality 25 / 30	$C = 0.20$	$\mu = 0.60$
$V_{Rd,i} \text{ [kN/m]}$		
Nevoga Plexus Type B		

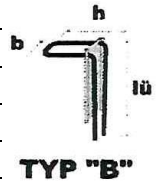

Box width B	85 mm	115 mm	145 mm	175 mm	205 mm	225 mm	mm
Anchorage	h = 15 cm	h = 15 cm	h = 15 cm	h = 15 cm	h = 15 cm	h = 15 cm	Pull-out
Ø 8-25	82.62	88.62	94.62	100.62	106.62	110.62	L <sub>s</sub> = 320 mm
Ø 8-20	99.11	105.11	111.11	117.11	123.11	127.11	
Ø 8-15	126.37	132.37	139.37	144.37	150.37	154.37	
Ø 8-10	181.06	187.06	193.06	199.06	205.06	209.06	

**TYP "B"**

Box width B	85 mm	115 mm	145 mm	175 mm	205 mm	225 mm	mm
Anchorage	h = 15 cm	h = 15 cm	h = 15 cm	h = 15 cm	h = 15 cm	h = 15 cm	Pull-out
Ø 10-25	93.45	99.45	105.45	111.45	117.45	121.45	L <sub>s</sub> = 390 mm
Ø 10-20	112.57	118.57	124.57	130.57	136.57	140.57	
Ø 10-15	144.46	150.46	156.46	162.46	168.46	172.46	
Ø 10-10	208.26	214.26	220.26	226.26	232.26	236.26	

Box width B	85 mm	115 mm	145 mm	175 mm	205 mm	225 mm	mm
Anchorage	h = 17 cm	h = 17 cm	h = 17 cm	h = 17 cm	h = 17 cm	h = 17 cm	Pull-out
Ø 12-25	118.83	124.83	130.83	136.83	142.83	146.83	L <sub>s</sub> = 460 mm
Ø 12-20	144.26	150.26	156.26	162.26	168.26	172.26	
Ø 12-15	186.68	192.68	198.68	204.68	210.68	214.68	
Ø 12-10	271.52	277.52	283.52	289.52	295.52	299.52	

Limitation by concrete strut (maximum value) indirect mounting in CS 1

$F_{cirl} = 1.0 \text{ MN/m}^2$	$a_1 < 50 \text{ mm}$	$v = 0.20$
Concrete quality 25 / 30	$C = 0.20$	$\mu = 0.60$
$V_{Rd,i,max} \text{ [kN/m]}$		
Nevoga Plexus Type B		



**TYP "B"**

Box width B	85 mm	115 mm	145 mm	175 mm	205 mm	225 mm	mm
Anchorage	h = 15 cm	h = 15 cm	h = 15 cm	h = 15 cm	h = 15 cm	h = 15 cm	Pull-out
Ø 8-25	120.42	162.92	205.42	247.92	290.42	318.75	L <sub>D</sub> = 320 mm
Ø 8-20	120.42	162.92	205.42	247.92	290.42	318.75	
Ø 8-15	120.42	162.92	205.42	247.92	290.42	318.75	
Ø 8-10	120.42	162.92	205.42	247.92	290.42	318.75	

Box width B	85 mm	115 mm	145 mm	175 mm	205 mm	225 mm	mm
Anchorage	h = 15 cm	h = 15 cm	h = 15 cm	h = 15 cm	h = 15 cm	h = 15 cm	Pull-out
Ø 10-25	120.42	162.92	205.42	247.92	290.42	318.75	L <sub>D</sub> = 390 mm
Ø 10-20	120.42	162.92	205.42	247.92	290.42	318.75	
Ø 10-15	120.42	162.92	205.42	247.92	290.42	318.75	
Ø 10-10	120.42	162.92	205.42	247.92	290.42	318.75	

Box width B	85 mm	115 mm	145 mm	175 mm	205 mm	225 mm	mm
Anchorage	h = 17 cm	h = 17 cm	h = 17 cm	h = 17 cm	h = 17 cm	h = 17 cm	Pull-out
Ø 12-25	120.42	162.92	205.42	247.92	290.42	318.75	L <sub>D</sub> = 460 mm
Ø 12-20	120.42	162.92	205.42	247.92	290.42	318.75	
Ø 12-15	120.42	162.92	205.42	247.92	290.42	318.75	
Ø 12-10	120.42	162.92	205.42	247.92	290.42	318.75	

Prüfamt für Standsicherheit  
LGA  
Zweigstelle Landshut  
S-LA  
of

Evaluation

Assumptions: Data sheet Reverse bending Fig. 8 a indirect mounting in CS 1

$\sigma_{cd} = () \text{ MN/m}^2$	$b_w = 1.0 \text{ m}$	$A_1 < 50 \text{ mm}$	$v = 0.20$
Concrete quality	25 / 30	$C = 0.20$	$\mu = 0.60$
$V_{Rd,i} [\text{kN/m}]$			
Nevoga Plexus Type B			



Box width B	85 mm	115 mm	145 mm	175 mm	205 mm	225 mm	mm
Anchorage	h = 15 cm	h = 15 cm	h = 15 cm	h = 15 cm	h = 15 cm	h = 15 cm	Pull-out
Ø 8-25	82.62	88.62	94.62	100.62	106.62	110.62	L <sub>s</sub> = 320 mm
Ø 8-20	99.11	105.11	111.11	117.11	123.11	127.11	
Ø 8-15	120.42	132.37	138.37	144.37	150.37	154.37	
Ø 8-10	120.42	162.92	193.06	199.06	205.96	209.96	

Box width B	85 mm	115 mm	145 mm	175 mm	205 mm	225 mm	mm
Anchorage	h = 15 cm	h = 15 cm	h = 15 cm	h = 15 cm	h = 15 cm	h = 15 cm	Pull-out
Ø 10-25	93.45	99.45	105.45	111.45	117.45	121.45	L <sub>s</sub> = 390 mm
Ø 10-20	112.57	118.57	124.57	130.57	136.57	140.57	
Ø 10-15	120.42	150.46	156.46	162.46	168.46	172.46	
Ø 10-10	120.42	162.92	205.42	226.26	232.26	236.26	

Box width B	85 mm	115 mm	145 mm	175 mm	205 mm	225 mm	mm
Anchorage	h = 17 cm	h = 17 cm	h = 17 cm	h = 17 cm	h = 17 cm	h = 17 cm	Pull-out
Ø 12-25	118.83	124.83	130.83	136.83	142.83	146.83	L <sub>s</sub> = 460 mm
Ø 12-20	120.42	150.26	156.26	162.26	168.26	172.26	
Ø 12-15	120.42	162.92	198.68	204.68	210.68	214.68	
Ø 12-10	120.42	162.92	205.42	247.92	290.42	299.52	

The verification of the pull-out lengths in construction section 2 must be carried out by the user!

Prüfamt für Standsicherheit  
**LGA**  
Zweigstelle Landshut  
S-LA of

Load tables Nevoga Plexus reinforcement connections

Absorbable shearing force lengthwise to the concrete joint (case a)

Total load-bearing capacity = load-bearing elements [concrete + friction] + reinforcement < maximum value

$$V_{rdi} = (c \times f_{ctd} + \mu \times \sigma_n) \times b + V_{Rdi,s} \leq V_{Rdi, max}$$

$$V_{rdi, max} = 0.5 \times v \times f_{cd} \times b$$

$$V_{rdi, s} = a_s \times f_{yd,red} \times (1.2 \times \mu \times \sin a + \cos a)$$

A<sub>s</sub> values (both rebars taken into account)

Values for direct mounting in construction section 1

Ø 8-25	4.44	4.44	4.44	4.44	4.44	4.44
Ø 8-20	5.55	5.55	5.55	5.55	5.55	5.55
Ø 8-15	7.41	7.41	7.41	7.41	7.41	7.41
Ø 8-10	11.11	11.11	11.11	11.11	11.11	11.11
Reduction	Factor l <sub>s, vorh.</sub> / l <sub>s, arf</sub>		Factor l <sub>b, dir. vorh.</sub> / l <sub>b, dir, arf</sub>			
Ø 10-25	5.18	5.18	5.18	5.18	5.18	5.18
Ø 10-20	6.47	6.47	6.47	6.47	6.47	6.47
Ø 10-15	8.63	8.63	8.63	8.63	8.63	8.63
Ø 10-10	12.95	12.95	12.95	12.95	12.95	12.95
Reduction of the A <sub>s</sub> values with the factor l <sub>b, dir, vorh.,</sub> /l <sub>b, dir, arf.</sub>						
Ø 12-25	6.89	6.89	6.89	6.89	6.89	6.89
Ø 12-20	8.61	8.61	8.61	8.61	8.61	8.61
Ø 12-15	11.49	11.49	11.49	11.49	11.49	11.49
Ø 12-10	17.23	17.23	17.23	17.23	17.23	17.23
Reduction of the A <sub>s</sub> values with the factor l <sub>b, dir, vorh.,</sub> /l <sub>b, dir, arf.</sub>						

Prüfamt für Standsicherheit  
**LGA**  
Zweigstelle Landshut  
S-LA of

**Non-certified translation from the German original.**

Fritsche Ingenieure

Ingenieurbüro für Bauwesen

Calculation of load capacity from concrete + friction + reinforcement direct mounting in CS 1

$F_{cirl} = 1.1 \text{ MN/m}^2$	$f_{yd} = 347.8 \text{ MN/M}^2$	$v = 0.20$
Concrete quality 30 / 37	$C = 0.20$	$\mu = 0.60$
$V_{Rd,i} \text{ [kN/m]}$		
Nevoga Plexus Type B		

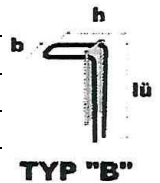

Box width B	85 mm	115 mm	145 mm	175 mm	205 mm	225 mm	mm
Anchorage	h = 15 cm	h = 15 cm	h = 15 cm	h = 15 cm	h = 15 cm	h = 15 cm	Pull-out
Ø 8-25	130.13	136.80	143.47	150.13	156.80	161.24	L <sub>s</sub> = 320 mm
Ø 8-20	157.99	164.65	171.32	177.99	184.65	189.10	
Ø 8-15	204.35	211.02	217.69	224.35	231.02	235.46	
Ø 8-10	297.09	303.75	310.42	317.09	323.75	328.20	

Box width B	85 mm	115 mm	145 mm	175 mm	205 mm	225 mm	mm
Anchorage	h = 15 cm	h = 15 cm	h = 15 cm	h = 15 cm	h = 15 cm	h = 15 cm	Pull-out
Ø 10-25	148.49	155.16	161.82	188.49	175.16	179.60	L <sub>s</sub> = 390 mm
Ø 10-20	180.89	187.56	194.22	200.89	207.56	212.00	
Ø 10-15	234.96	241.63	248.29	254.96	261.63	266.07	
Ø 10-10	343.10	349.77	356.43	363.10	369.77	374.21	

Box width B	85 mm	115 mm	145 mm	175 mm	205 mm	225 mm	mm
Anchorage	h = 17 cm	h = 17 cm	h = 17 cm	h = 17 cm	h = 17 cm	h = 17 cm	Pull-out
Ø 12-25	191.51	198.17	204.84	211.51	218.17	222.62	L <sub>s</sub> = 460 mm
Ø 12-20	234.61	241.28	247.95	254.61	261.28	265.73	
Ø 12-15	306.52	313.19	319.86	326.52	333.19	337.63	
Ø 12-10	450.34	457.01	463.67	470.34	477.01	481.45	

Limitation by concrete strut (maximum value) direct mounting in CS 1

$F_{cirl} = 1.1 \text{ MN/m}^2$	$a_1 < 50 \text{ mm}$	$v = 0.20$
Concrete quality 30 / 37	$C = 0.20$	$\mu = 0.60$
$V_{Rd,i,max} \text{ [kN/m]}$		
Nevoga Plexus Type B		

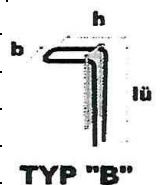

Box width B	85 mm	115 mm	145 mm	175 mm	205 mm	225 mm	mm
Anchorage	h = 15 cm	h = 15 cm	h = 15 cm	h = 15 cm	h = 15 cm	h = 15 cm	Pull-out
Ø 8-25	144.50	195.50	246.50	297.50	348.50	382.50	L <sub>D</sub> = 320 mm
Ø 8-20	144.50	195.50	246.50	297.50	348.50	382.50	
Ø 8-15	144.50	195.50	246.50	297.50	348.50	382.50	
Ø 8-10	144.50	195.50	246.50	297.50	348.50	382.50	

Box width B	85 mm	115 mm	145 mm	175 mm	205 mm	225 mm	mm
Anchorage	h = 15 cm	h = 15 cm	h = 15 cm	h = 15 cm	h = 15 cm	h = 15 cm	Pull-out
Ø 10-25	144.50	195.50	246.50	297.50	348.50	382.50	L <sub>D</sub> = 390 mm
Ø 10-20	144.50	195.50	246.50	297.50	348.50	382.50	
Ø 10-15	144.50	195.50	246.50	297.50	348.50	382.50	
Ø 10-10	144.50	195.50	246.50	297.50	348.50	382.50	

Box width B	85 mm	115 mm	145 mm	175 mm	205 mm	225 mm	mm
Anchorage	h = 17 cm	h = 17 cm	h = 17 cm	h = 17 cm	h = 17 cm	h = 17 cm	Pull-out
Ø 12-25	144.50	195.50	246.50	297.50	348.50	382.50	L <sub>D</sub> = 460 mm
Ø 12-20	144.50	195.50	246.50	297.50	348.50	382.50	
Ø 12-15	144.50	195.50	246.50	297.50	348.50	382.50	
Ø 12-10	144.50	195.50	246.50	297.50	348.50	382.50	

amt für Standsicherheit  
LGA  
Zweigstelle Landshut  
S-LA of

Evaluation

Assumptions: Data sheet Reverse bending Fig. 8 a

indirect mounting in CS 1

$\sigma_{cd} = () \text{ MN/m}^2$ $b_w = 1.0 \text{ m}$	$A_1 < 50 \text{ mm}$ $v = 0.20$
Concrete quality 30 / 37	$C = 0.20$ $\mu = 0.60$
$V_{Rd,i} [\text{kN/m}]$	
Nevoga Plexus Type B	



Box width B	85 mm	115 mm	145 mm	175 mm	205 mm	225 mm	mm
Anchorage	h = 15 cm	h = 15 cm	h = 15 cm	h = 15 cm	h = 15 cm	h = 15 cm	Pull-out
Ø 8-25	130.13	136.80	143.47	150.13	156.80	161.24	L <sub>s</sub> = 320 mm
Ø 8-20	144.50	164.65	171.32	177.99	184.85	189.10	
Ø 8-15	144.50	195.50	217.69	224.35	231.02	235.46	
Ø 8-10	144.50	195.50	246.50	297.50	323.75	328.20	

Box width B	85 mm	115 mm	145 mm	175 mm	205 mm	225 mm	mm
Anchorage	h = 15 cm	h = 15 cm	h = 15 cm	h = 15 cm	h = 15 cm	h = 15 cm	Pull-out
Ø 10-25	144.50	155.16	161.82	168.49	175.16	179.80	L <sub>s</sub> = 390 mm
Ø 10-20	144.50	187.56	194.22	200.89	207.56	212.00	
Ø 10-15	144.50	195.50	246.50	254.96	261.63	266.07	
Ø 10-10	144.50	195.50	246.50	297.50	348.50	374.21	

Box width B	85 mm	115 mm	145 mm	175 mm	205 mm	225 mm	mm
Anchorage	h = 17 cm	h = 17 cm	h = 17 cm	h = 17 cm	h = 17 cm	h = 17 cm	Pull-out
Ø 12-25	144.50	195.50	204.84	211.51	218.17	222.62	L <sub>s</sub> = 460 mm
Ø 12-20	144.50	195.50	246.50	254.61	261.28	265.73	
Ø 12-15	144.50	195.50	246.50	297.50	333.19	337.63	
Ø 12-10	144.50	195.50	246.50	297.50	348.50	382.50	

The verification of the pull-out lengths in construction section 2 must be carried out by the user!

The boundary conditions, whether direct or indirect mounting of construction section 1 was given, must be checked by the user!

Prüfamt für Standsicherheit  
**LGA**  
Zweigstelle Landshut

S-LA \_\_\_\_\_ of \_\_\_\_\_

Load tables Nevoga Plexus reinforcement connections

Absorbable shearing force lengthwise to the concrete joint (case a)

Total load-bearing capacity = load-bearing elements [concrete + friction] + reinforcement < maximum value

$$V_{rdi} = (c \times f_{ctd} + \mu \times \sigma_n) \times b + V_{Rdi,s} \leq V_{Rdi, max}$$

$$V_{rdi, max} = 0.5 \times v \times f_{cd} \times b$$

$$V_{rdi, s} = a_s \times f_{yd,red} \times (1.2 \times \mu \times \sin a + \cos a)$$

A<sub>s</sub> values (both rebars taken into account)

Values for indirect mounting in construction section 1

Ø 8-25	2.96	2.96	2.96	2.96	2.96	2.96
Ø 8-20	3.71	3.71	3.71	3.71	3.71	3.71
Ø 8-15	4.94	4.94	4.94	4.94	4.94	4.94
Ø 8-10	7.40	7.40	7.40	7.40	7.40	7.40
Reduction of the A <sub>s</sub> values with the factor $l_{b,Ind, vorh.} / l_{b, dir, arf.}$						
Ø 10-25	3.45	3.45	3.45	3.45	3.45	3.45
Ø 10-20	4.31	4.31	4.31	4.31	4.31	4.31
Ø 10-15	5.75	5.75	5.75	5.75	5.75	5.75
Ø 10-10	8.63	8.63	8.63	8.63	8.63	8.63
Reduction of the A <sub>s</sub> values with the factor $l_{b,Ind, vorh.} / l_{b, dir, arf.}$						
Ø 12-25	4.60	4.60	4.60	4.60	4.60	4.60
Ø 12-20	5.74	5.74	5.74	5.74	5.74	5.74
Ø 12-15	7.66	7.66	7.66	7.66	7.66	7.66
Ø 12-10	11.49	11.49	11.49	11.49	11.49	11.49
Reduction of the A <sub>s</sub> values with the factor $l_{b,Ind, vorh.} / l_{b, dir, arf.}$						

Prüfamt für Standsicherheit  
**LGA**  
Zweigstelle Landshut  
S-LA of



**Non-certified translation from the German original.**

Fritsche Ingenieure

Ingenieurbüro für Bauwesen

Calculation of load capacity from concrete + friction + reinforcement indirect mounting in CS 1

$F_{cirl} = 1.1 \text{ MN/m}^2$	$f_{yd} = 347.8 \text{ MN/M}^2$	$v = 0.20$
Concrete quality 30 / 37	$C = 0.20$	$\mu = 0.60$
$V_{Rd,i} \text{ [kN/m]}$		
Nevoga Plexus Type B		

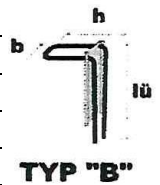

Box width B	85 mm	115 mm	145 mm	175 mm	205 mm	225 mm	mm
Anchorage	h = 15 cm	h = 15 cm	h = 15 cm	h = 15 cm	h = 15 cm	h = 15 cm	Pull-out
Ø 8-25	93.05	99.72	106.39	113.05	119.72	124.16	L <sub>s</sub> = 320 mm
Ø 8-20	111.68	118.35	125.02	131.68	138.35	142.80	
Ø 8-15	142.29	149.16	155.83	162.49	169.16	173.60	
Ø 8-10	204.30	210.96	217.63	224.30	230.96	235.41	

Box width B	85 mm	115 mm	145 mm	175 mm	205 mm	225 mm	mm
Anchorage	h = 15 cm	h = 15 cm	h = 15 cm	h = 15 cm	h = 15 cm	h = 15 cm	Pull-out
Ø 10-25	105.29	111.96	118.82	125.29	131.96	136.40	L <sub>s</sub> = 390 mm
Ø 10-20	126.89	133.58	140.22	146.89	153.56	158.00	
Ø 10-15	162.94	169.60	176.27	182.94	189.60	194.05	
Ø 10-10	235.03	241.70	248.36	255.03	261.70	266.14	

Box width B	85 mm	115 mm	145 mm	175 mm	205 mm	225 mm	mm
Anchorage	h = 17 cm	h = 17 cm	h = 17 cm	h = 17 cm	h = 17 cm	h = 17 cm	Pull-out
Ø 12-25	133.97	140.63	147.30	153.97	160.63	165.08	L <sub>s</sub> = 460 mm
Ø 12-20	162.71	169.37	176.04	182.71	189.37	193.82	
Ø 12-15	210.64	217.31	223.98	230.64	237.31	241.76	
Ø 12-10	306.52	313.19	319.86	326.52	333.19	337.63	

Limitation by concrete strut (maximum value) indirect mounting in CS 1

$F_{cirl} = 1.1 \text{ MN/m}^2$	$a_1 = < 50 \text{ mm}$	$v = 0.20$
Concrete quality 30 / 37	$C = 0.20$	$\mu = 0.60$
$V_{Rd,i,max} \text{ [kN/m]}$		
Nevoga Plexus Type B		



Box width B	85 mm	115 mm	145 mm	175 mm	205 mm	225 mm	mm
Anchorage	h = 15 cm	h = 15 cm	h = 15 cm	h = 15 cm	h = 15 cm	h = 15 cm	Pull-out
Ø 8-25	144.50	195.50	246.50	297.50	348.50	382.50	L <sub>s</sub> = 320 mm
Ø 8-20	144.50	195.50	246.50	297.50	348.50	382.50	
Ø 8-15	144.50	195.50	246.50	297.50	348.50	382.50	
Ø 8-10	144.50	195.50	246.50	297.50	348.50	382.50	

Box width B	85 mm	115 mm	145 mm	175 mm	205 mm	225 mm	mm
Anchorage	h = 15 cm	h = 15 cm	h = 15 cm	h = 15 cm	h = 15 cm	h = 15 cm	Pull-out
Ø 10-25	144.50	195.50	246.50	297.50	348.50	382.50	L <sub>s</sub> = 390 mm
Ø 10-20	144.50	195.50	246.50	297.50	348.50	382.50	
Ø 10-15	144.50	195.50	246.50	297.50	348.50	382.50	
Ø 10-10	144.50	195.50	246.50	297.50	348.50	382.50	

Box width B	85 mm	115 mm	145 mm	175 mm	205 mm	225 mm	mm
Anchorage	h = 17 cm	h = 17 cm	h = 17 cm	h = 17 cm	h = 17 cm	h = 17 cm	Pull-out
Ø 12-25	144.50	195.50	246.50	297.50	348.50	382.50	L <sub>s</sub> = 460 mm
Ø 12-20	144.50	195.50	246.50	297.50	348.50	382.50	
Ø 12-15	144.50	195.50	246.50	297.50	348.50	382.50	
Ø 12-10	144.50	195.50	246.50	297.50	348.50	382.50	

Prüfamt für  
IGA  
Zweigstelle  
S-LA  
Standortsicherheit  
Landshut  
of

**Non-certified translation from the German original.**

Fritsche Ingenieure  
Ingenieurbüro für Bauwesen

Evaluation

Assumptions: Data sheet Reverse bending Fig. 8 a indirect mounting in CS 1

$\sigma_{cd} = () \text{ MN/m}^2$	$b_w = 1.0 \text{ m}$	$A_1 < 50 \text{ mm}$	$v = 0.20$
Concrete quality 30 / 37		$C = 0.20$	$\mu = 0.60$
$V_{Rd,i} [\text{kN/m}]$			
Nevoga Plexus Type B			



Box width B	85 mm	115 mm	145 mm	175 mm	205 mm	225 mm	mm
Anchorage	h = 15 cm	h = 15 cm	h = 15 cm	h = 15 cm	h = 15 cm	h = 15 cm	Pull-out
Ø 8-25	93.05	99.72	106.39	113.05	119.72	124.16	L <sub>s</sub> = 320 mm
Ø 8-20	111.68	118.35	125.02	131.68	138.35	142.80	
Ø 8-15	142.49	149.16	155.83	162.49	169.16	173.60	
Ø 8-10	144.50	195.50	217.63	224.30	230.96	235.41	

Box width B	85 mm	115 mm	145 mm	175 mm	205 mm	225 mm	mm
Anchorage	h = 15 cm	h = 15 cm	h = 15 cm	h = 15 cm	h = 15 cm	h = 15 cm	Pull-out
Ø 10-25	105.29	111.96	118.62	125.29	131.96	136.40	L <sub>s</sub> = 390 mm
Ø 10-20	126.89	133.56	140.22	146.89	153.56	158.00	
Ø 10-15	144.50	169.60	176.27	182.94	189.60	194.05	
Ø 10-10	144.50	195.50	246.50	255.03	261.70	266.14	

Box width B	85 mm	115 mm	145 mm	175 mm	205 mm	225 mm	mm
Anchorage	h = 17 cm	h = 17 cm	h = 17 cm	h = 17 cm	h = 17 cm	h = 17 cm	Pull-out
Ø 12-25	133.97	140.63	147.30	153.97	160.63	165.08	L <sub>s</sub> = 460 mm
Ø 12-20	144.50	169.37	176.04	182.71	189.37	193.82	
Ø 12-15	144.50	195.50	223.98	230.64	237.31	241.76	
Ø 12-10	144.50	195.50	246.50	297.50	333.19	337.63	

The verification of the pull-out lengths in construction section 2 must be carried out by the user!

Prüfamf für Standsicherheit  
**LGA**  
 Zweigstelle Landshut  
 S-LA \_\_\_\_\_ of



Load tables Nevoga Plexus reinforcement connections

Absorbable shearing force lengthwise to the concrete joint (case b)

Total load-bearing capacity = load-bearing elements [concrete + friction] + reinforcement < maximum value

$$V_{rdi} = (c \times f_{ctd} + \mu \times \sigma_n) \times b + V_{Rdi,s} \leq V_{Rdi, max}$$

$$V_{rdi, max} = 0.5 \times v \times f_{cd} \times b$$

$$V_{rdi, s} = a_s \times f_{yd,red} \times (1.2 \times \mu \times \sin a + \cos a)$$

A<sub>s</sub> values (both rebars taken into account)

Values for indirect mounting in construction section 1

Ø 8-25	2.26	2.26	2.26	2.26	2.26	2.26	2.26	2.26
Ø 8-20	2.83	2.83	2.83	2.83	2.83	2.83	2.83	2.83
Ø 8-15	3.77	3.77	3.77	3.77	3.77	3.77	3.77	3.77
Ø 8-10	5.65	5.65	5.65	5.65	5.65	5.65	5.65	5.65
Reduction of the A <sub>s</sub> values with the factor l <sub>b,dir, vorh.</sub> /l <sub>b, dir, arf.</sub>								
Ø 10-25	2.63	2.63	2.63	2.63	2.63	2.63	2.63	2.63
Ø 10-20	3.29	3.29	3.29	3.29	3.29	3.29	3.29	3.29
Ø 10-15	4.39	4.39	4.39	4.39	4.39	4.39	4.39	4.39
Ø 10-10	6.59	6.59	6.59	6.59	6.59	6.59	6.59	6.59
Reduction of the A <sub>s</sub> values with the factor l <sub>b,dir, vorh.</sub> /l <sub>b, dir, arf.</sub>								
Ø 12-25	3.51	3.51	3.51	3.51	3.51	3.51	3.51	3.51
Ø 12-20	4.38	4.38	4.38	4.38	4.38	4.38	4.38	4.38
Ø 12-15	5.84	5.84	5.84	5.84	5.84	5.84	5.84	5.84
Ø 12-10	8.77	8.77	8.77	8.77	8.77	8.77	8.77	8.77
Reduction of the A <sub>s</sub> values with the factor l <sub>b,dir, vorh.</sub> /l <sub>b, dir, arf.</sub>								

**Non-certified translation from the German original.**

Calculation of load capacity from concrete + friction = reinforcement

$F_{cirl} = 0.8 \text{ MN/m}^2$	$F_{yd,red} = 347.8 \text{ MN/m}^2$	$v = 0.20$
Concrete quality 20 / 25	$C = 0.20$	$\mu = 0.60$
$V_{Rd,i} \text{ [kN/m]}$		
Nevoga Plexus Type A, I, M		

B	200 mm	250 mm	275 mm	300 mm	325 mm	350 mm	375 mm	400 mm	mm
Anchorage	h = 15 cm	h = 15 cm	h = 15 cm	h = 15 cm	h = 15 cm	h = 15 cm	h = 15 cm	h = 15 cm	Pull-out
Ø 8-25	89.93	98.26	102.43	106.60	110.76	114.93	119.10	123.26	L <sub>s</sub> = 320 mm
Ø 8-20	104.15	112.48	116.65	120.82	124.98	129.15	133.32	137.48	
Ø 8-15	127.66	136.00	140.16	144.33	148.50	152.66	156.83	161.00	
Ø 8-10	174.83	183.16	187.33	191.49	195.66	199.83	203.99	208.16	



B	200 mm	250 mm	275 mm	300 mm	325 mm	350 mm	375 mm	400 mm	mm
Anchorage	h = 15 cm	h = 15 cm	h = 15 cm	h = 15 cm	h = 15 cm	h = 15 cm	h = 15 cm	h = 15 cm	Pull-out
Ø 8-25	99.27	107.60	111.77	115.94	120.10	124.27	128.44	132.60	L <sub>s</sub> = 390 mm
Ø 8-20	115.76	124.09	128.26	132.42	136.59	140.76	144.92	149.09	
Ø 8-15	143.26	151.60	155.76	159.93	164.10	168.26	172.43	176.60	
Ø 8-10	198.28	206.62	210.78	214.95	219.12	223.28	227.45	231.62	



B	200 mm	250 mm	275 mm	300 mm	325 mm	350 mm	375 mm	400 mm	mm
Anchorage	h = 17 cm	h = 17 cm	h = 17 cm	h = 17 cm	h = 17 cm	h = 17 cm	h = 17 cm	h = 17 cm	Pull-out
Ø 8-25	121.16	129.49	133.66	137.82	141.99	146.16	150.32	154.49	L <sub>s</sub> = 460 mm
Ø 8-20	143.09	151.42	155.59	159.75	163.92	168.09	172.25	176.42	
Ø 8-15	179.67	168.01	192.17	196.34	200.51	204.67	208.84	213.01	
Ø 8-10	252.84	261.18	265.34	269.51	273.68	277.84	282.01	286.18	



Limitation by concrete strut (maximum value)

$F_{cirl} = 0.8 \text{ MN/m}^2$	$a_1 < 50 \text{ mm}$	$v = 0.20$
Concrete quality 20 / 25	$C = 0.20$	$\mu = 0.60$
$V_{Rd,i,max} \text{ [kN/m]}$		
Nevoga Plexus Type A, I, M		

B	200 mm	250 mm	275 mm	300 mm	325 mm	350 mm	375 mm	400 mm	mm
Anchorage	h = 15 cm	h = 15 cm	h = 15 cm	h = 15 cm	h = 15 cm	h = 15 cm	h = 15 cm	h = 15 cm	Pull-out
∅ 8-25	226.67	283.33	311.67	340.00	368.33	396.67	425.00	453.33	L <sub>s</sub> = 320 mm
∅ 8-20	226.67	283.33	311.67	340.00	368.33	396.67	425.00	453.33	
∅ 8-15	226.67	283.33	311.67	340.00	368.33	396.67	425.00	453.33	
∅ 8-10	226.67	283.33	311.67	340.00	368.33	396.67	425.00	453.33	



B	200 mm	250 mm	275 mm	300 mm	325 mm	350 mm	375 mm	400 mm	mm
Anchorage	h = 15 cm	h = 15 cm	h = 15 cm	h = 15 cm	h = 15 cm	h = 15 cm	h = 15 cm	h = 15 cm	Pull-out
∅ 8-25	226.67	283.33	311.67	340.00	368.33	396.67	425.00	453.33	L <sub>s</sub> = 390 mm
∅ 8-20	226.67	283.33	311.67	340.00	368.33	396.67	425.00	453.33	
∅ 8-15	226.67	283.33	311.67	340.00	368.33	396.67	425.00	453.33	
∅ 8-10	226.67	283.33	311.67	340.00	368.33	396.67	425.00	453.33	

B	200 mm	250 mm	275 mm	300 mm	325 mm	350 mm	375 mm	400 mm	mm
Anchorage	h = 17 cm	h = 17 cm	h = 17 cm	h = 17 cm	h = 17 cm	h = 17 cm	h = 17 cm	h = 17 cm	Pull-out
∅ 8-25	226.67	283.33	311.67	340.00	368.33	396.67	425.00	453.33	L <sub>s</sub> = 460 mm
∅ 8-20	226.67	283.33	311.67	340.00	368.33	396.67	425.00	453.33	
∅ 8-15	226.67	283.33	311.67	340.00	368.33	396.67	425.00	453.33	
∅ 8-10	226.67	283.33	311.67	340.00	368.33	396.67	425.00	453.33	

Prüfamt für Standsicherheit  
**LGA**  
Zweigstelle Landshut  
S-LA of

Evaluation

Assumptions: Data sheet reverse bending figure 8 b

B = Design width of wall = Wall thickness - 2a <sub>1</sub>		
a <sub>2</sub> ≥ 50 mm with surface finish smooth according to DIN EN 1992-1-1 6.2.5		
σ <sub>cd</sub> = ( ) MN/m <sup>2</sup>	A <sub>1</sub> < 50 mm v = 0.20	
Concrete quality 20 / 25	C = 0.20	μ = 0.60
V <sub>Rd,i</sub> [kN/m]		
Nevoga Plexus Type A, I, M		

B	200 mm	250 mm	275 mm	300 mm	325 mm	350 mm	375 mm	400 mm	mm
Anchorage	h = 15 cm	h = 15 cm	h = 15 cm	h = 15 cm	h = 15 cm	h = 15 cm	h = 15 cm	h = 15 cm	Pull-out
∅ 8-25	89.93	98.26	102.43	106.60	110.76	114.93	119.10	123.26	L <sub>s</sub> = 320 mm
∅ 8-20	104.15	112.48	116.65	120.82	124.98	129.15	133.32	137.48	
∅ 8-15	127.66	136.00	140.16	144.33	148.50	152.66	203.99	208.16	
∅ 8-10	174.83	183.16	187.33	191.49	195.66	199.83	203.99	208.16	



B	200 mm	250 mm	275 mm	300 mm	325 mm	350 mm	375 mm	400 mm	mm
Anchorage	h = 15 cm	h = 15 cm	h = 15 cm	h = 15 cm	h = 15 cm	h = 15 cm	h = 15 cm	h = 15 cm	Pull-out
∅ 8-25	99.27	107.60	111.77	115.94	120.10	124.27	128.44	132.60	L <sub>s</sub> = 390 mm
∅ 8-20	115.76	124.09	128.26	132.42	135.59	140.76	144.92	149.09	
∅ 8-15	143.26	151.60	155.76	159.93	164.10	168.26	172.43	176.60	
∅ 8-10	198.28	206.62	210.78	214.95	219.12	223.28	227.45	231.62	



B	200 mm	250 mm	275 mm	300 mm	325 mm	350 mm	375 mm	400 mm	mm
Anchorage	h = 17 cm	h = 17 cm	h = 17 cm	h = 17 cm	h = 17 cm	h = 17 cm	h = 17 cm	h = 17 cm	Pull-out
∅ 8-25	121.15	129.49	133.66	137.82	141.99	146.16	150.32	154.49	L <sub>s</sub> = 460 mm
∅ 8-20	143.09	151.42	155.59	159.75	163.92	168.09	172.25	176.42	
∅ 8-15	179.67	188.01	192.17	196.34	200.51	204.67	208.84	213.01	
∅ 8-10	226.67	261.18	265.34	269.51	273.68	277.84	282.01	286.18	



The verification of the pull-out lengths in construction section 2 must be carried out by the user!

Prüfamt für Standsicherheit  
LGA  
Zweigstelle Landshut  
S-LA of

Load tables Nevoga Plexus reinforcement connections

Absorbable shearing force lengthwise to the concrete joint (case b)

Total load-bearing capacity = load-bearing elements [concrete + friction] + reinforcement < maximum value

$$V_{rdi} = (c \times f_{ctd} + \mu \times \sigma_n) \times b + V_{Rdi,s} \leq V_{Rdi, max}$$

$$V_{rdi, max} = 0.5 \times v \times f_{cd} \times b$$

$$V_{rdi, s} = a_s \times f_{yd, red} \times (1.2 \times \mu \times \sin a + \cos a)$$

A<sub>s</sub> values (both rebars taken into account)

Values for indirect mounting in construction section 1

Ø 8-25	2.26	2.26	2.26	2.26	2.26	2.26	2.26	2.26
Ø 8-20	3.28	3.28	3.28	3.28	3.28	3.28	3.28	3.28
Ø 8-15	4.37	4.37	4.37	4.37	4.37	4.37	4.37	4.37
Ø 8-10	6.55	6.55	6.55	6.55	6.55	6.55	6.55	6.55
Reduction	Factor I <sub>s, vorh.</sub> / I <sub>s, arf</sub>			Factor I <sub>b, dir. vorh.</sub> / I <sub>b, dir, arf</sub>				
Ø 10-25	3.05	3.05	3.05	3.05	3.05	3.05	3.05	3.05
Ø 10-20	3.82	3.82	3.82	3.82	3.82	3.82	3.82	3.82
Ø 10-15	5.09	5.09	5.09	5.09	5.09	5.09	5.09	5.09
Ø 10-10	7.64	7.64	7.64	7.64	7.64	7.64	7.64	7.64
	Reduction of the A <sub>s</sub> values with the factor I <sub>b, dir, vorh.</sub> / I <sub>b, dir, arf</sub> .							
Ø 12-25	4.07	4.07	4.07	4.07	4.07	4.07	4.07	4.07
Ø 12-20	5.08	5.08	5.08	5.08	5.08	5.08	5.08	5.08
Ø 12-15	6.78	6.78	6.78	6.78	6.78	6.78	6.78	6.78
Ø 12-10	10.16	10.16	10.16	10.16	10.16	10.16	10.16	10.16
	Reduction of the A <sub>s</sub> values with the factor I <sub>b, dir, vorh.</sub> / I <sub>b, dir, arf</sub> .							



**Non-certified translation from the German original.**

Calculation of load capacity from concrete + friction = reinforcement

$F_{cirl} = 1.0 \text{ MN/m}^2$	$F_{yd,red} = 347.8 \text{ MN/m}^2$	$v = 0.20$
Concrete quality 25 / 30	$C = 0.20$	$\mu = 0.60$
$V_{Rd,i} \text{ [kN/m]}$		
Nevoga Plexus Type A, I, M		

B	200 mm	250 mm	275 mm	300 mm	325 mm	350 mm	375 mm	400 mm	mm
Anchorage	h = 15 cm	h = 15 cm	h = 15 cm	h = 15 cm	h = 15 cm	h = 15 cm	h = 15 cm	h = 15 cm	Pull-out
∅ 8-25	105.62	115.62	120.62	125.62	130.62	135.62	140.62	145.62	L <sub>s</sub> = 320 mm
∅ 8-20	122.11	132.11	137.11	142.11	147.11	152.11	157.11	162.11	
∅ 8-15	149.37	159.37	164.37	169.37	174.37	179.37	184.37	189.37	
∅ 8-10	204.06	214.06	219.06	224.06	229.06	234.06	239.06	244.06	



B	200 mm	250 mm	275 mm	300 mm	325 mm	350 mm	375 mm	400 mm	mm
Anchorage	h = 15 cm	h = 15 cm	h = 15 cm	h = 15 cm	h = 15 cm	h = 15 cm	h = 15 cm	h = 15 cm	Pull-out
∅ 10-25	116.45	126.45	131.45	136.45	141.45	146.45	151.45	155.45	L <sub>s</sub> = 390 mm
∅ 10-20	135.57	145.57	150.57	155.57	160.57	165.57	170.57	175.57	
∅ 10-15	167.46	177.46	182.46	187.46	192.46	197.46	202.46	207.46	
∅ 10-10	231.26	241.26	246.26	251.26	256.26	261.26	266.26	271.26	

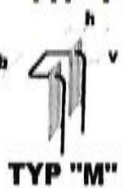

B	200 mm	250 mm	275 mm	300 mm	325 mm	350 mm	375 mm	400 mm	mm
Anchorage	h = 17 cm	h = 17 cm	h = 17 cm	h = 17 cm	h = 17 cm	h = 17 cm	h = 17 cm	h = 17 cm	Pull-out
∅ 12-25	141.83	151.83	156.83	161.83	166.83	171.83	176.83	181.83	L <sub>s</sub> = 460 mm
∅ 12-20	167.27	177.26	182.26	187.26	192.26	197.25	202.26	207.26	
∅ 12-15	209.68	219.68	224.68	229.68	234.68	239.68	244.68	249.68	
∅ 12-10	294.52	304.52	309.52	314.52	319.52	324.52	329.52	334.52	

Prüfamf für Standsicherheit  
**LGA**  
 Zweigstelle Landshut  
 S-LA of

**Non-certified translation from the German original.**

Limitation by concrete strut (maximum value)

$F_{cirl} = 1.0 \text{ MN/m}^2$	$a_1 < 50 \text{ mm}$	$v = 0.20$
Concrete quality 25 / 30	$C = 0.20$	$\mu = 0.60$
$V_{Rd,i,max} \text{ [kN/m]}$		
Nevoga Plexus Type A, I, M		

B	200 mm	250 mm	275 mm	300 mm	325 mm	350 mm	375 mm	400 mm	mm
Anchorage	h = 15 cm	h = 15 cm	h = 15 cm	h = 15 cm	h = 15 cm	h = 15 cm	h = 15 cm	h = 15 cm	Pull-out
Ø 8-25	283.33	354.17	389.58	425.00	460.42	495.83	531.25	566.67	L <sub>s</sub> = 320 mm
Ø 8-20	283.33	354.17	389.58	425.00	460.42	495.83	531.25	566.67	
Ø 8-15	283.33	354.17	389.58	425.00	460.42	495.83	531.25	566.67	
Ø 8-10	283.33	354.17	389.58	425.00	460.42	495.83	531.25	566.67	

B	200 mm	250 mm	275 mm	300 mm	325 mm	350 mm	375 mm	400 mm	mm
Anchorage	h = 15 cm	h = 15 cm	h = 15 cm	h = 15 cm	h = 15 cm	h = 15 cm	h = 15 cm	h = 15 cm	Pull-out
Ø 8-25	283.33	354.17	389.58	425.00	460.42	495.83	531.25	566.67	L <sub>s</sub> = 390 mm
Ø 8-20	283.33	354.17	389.58	425.00	460.42	495.83	531.25	566.67	
Ø 8-15	283.33	354.17	389.58	425.00	460.42	495.83	531.25	566.67	
Ø 8-10	283.33	354.17	389.58	425.00	460.42	495.83	531.25	566.67	

B	200 mm	250 mm	275 mm	300 mm	325 mm	350 mm	375 mm	400 mm	mm
Anchorage	h = 17 cm	h = 17 cm	h = 17 cm	h = 17 cm	h = 17 cm	h = 17 cm	h = 17 cm	h = 17 cm	Pull-out
Ø 8-25	283.33	354.17	389.58	425.00	460.42	495.83	531.25	566.67	L <sub>s</sub> = 460 mm
Ø 8-20	283.33	354.17	389.58	425.00	460.42	495.83	531.25	566.67	
Ø 8-15	283.33	354.17	389.58	425.00	460.42	495.83	531.25	566.67	
Ø 8-10	283.33	354.17	389.58	425.00	460.42	495.83	531.25	566.67	

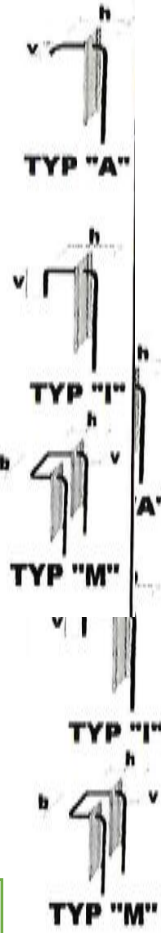

Prüfamf für Standsicherheit  
**LGA**  
 Zweigstelle Landshut  
 S-LA of

Evaluation

Assumptions: Data sheet reverse bending figure 8 b

B = Design width of wall = Wall thickness - 2a <sub>1</sub>		
a <sub>2</sub> ≥ 50 mm with surface finish smooth according to DIN EN 1992-1-1 6.2.5		
σ <sub>cd</sub> = ( ) MN/m <sup>2</sup>	A <sub>1</sub> < 50 mm v = 0.20	
Concrete quality 25 / 30	C = 0.20	μ = 0.60
V <sub>Rd,i</sub> [kN/m]		
Nevoga Plexus Type A, I, M		

B	200 mm	250 mm	275 mm	300 mm	325 mm	350 mm	375 mm	400 mm	mm
Anchorage	h = 15 cm	h = 15 cm	h = 15 cm	h = 15 cm	h = 15 cm	h = 15 cm	h = 15 cm	h = 15 cm	Pull-out
∅ 8-25	105.62	115.62	120.62	125.62	130.62	135.63	140.62	145.62	L <sub>s</sub> = 320 mm
∅ 8-20	122.11	132.11	137.11	142.11	147.11	152.11	157.11	162.11	
∅ 8-15	149.37	159.37	164.37	169.37	174.37	179.37	184.37	189.37	
∅ 8-10	204.06	214.06	219.06	224.06	229.06	234.06	239.06	244.06	



B	200 mm	250 mm	275 mm	300 mm	325 mm	350 mm	375 mm	400 mm	mm
Anchorage	h = 15 cm	h = 15 cm	h = 15 cm	h = 15 cm	h = 15 cm	h = 15 cm	h = 15 cm	h = 15 cm	Pull-out
∅ 8-25	116.45	126.45	131.45	136.45	141.45	146.45	151.45	156.45	L <sub>s</sub> = 390 mm
∅ 8-20	135.57	145.57	150.57	155.57	160.57	165.57	170.57	175.57	
∅ 8-15	167.46	177.46	182.46	187.46	192.46	197.46	202.46	207.46	
∅ 8-10	231.26	241.26	246.26	251.26	256.26	261.26	266.26	271.26	



B	200 mm	250 mm	275 mm	300 mm	325 mm	350 mm	375 mm	400 mm	mm
Anchorage	h = 17 cm	h = 17 cm	h = 17 cm	h = 17 cm	h = 17 cm	h = 17 cm	h = 17 cm	h = 17 cm	Pull-out
∅ 8-25	141.83	151.83	156.83	161.83	166.83	171.83	176.83	181.83	L <sub>s</sub> = 460 mm
∅ 8-20	167.26	177.26	182.26	187.26	192.26	197.26	202.26	207.26	
∅ 8-15	209.68	219.68	224.68	229.68	234.68	239.68	244.68	249.68	
∅ 8-10	283.33	304.52	309.52	314.52	319.52	324.52	329.52	334.52	



The verification of the pull-out lengths in construction section 2 must be carried out by the user!

Prüfamt für Standsicherheit  
LGA  
Zweigstelle Landshut  
S-LA of

Load tables Nevoga Plexus reinforcement connections

Absorbable shearing force lengthwise to the concrete joint (case b)

Total load-bearing capacity = load-bearing elements [concrete + friction] + reinforcement < maximum value

$$V_{rdi} = (c \times f_{ctd} + \mu \times \sigma_n) \times b + V_{Rdi,s} \leq V_{Rdi, max}$$

$$V_{rdi, max} = 0.5 \times v \times f_{cd} \times b$$

$$V_{rdi, s} = a_s \times f_{yd,red} \times (1.2 \times \mu \times \sin a + \cos a)$$

$A_s$  values (both rebars taken into account)

Values for indirect mounting in construction section 1

Ø 8-25	2.96	2.96	2.96	2.96	2.96	2.96	2.96	2.96
Ø 8-20	3.71	3.71	3.71	3.71	3.71	3.71	3.71	3.71
Ø 8-15	4.94	4.94	4.94	4.94	4.94	4.94	4.94	4.94
Ø 8-10	7.40	7.40	7.40	7.40	7.40	7.40	7.40	7.40
Reduction of the $A_s$ values with the factor $l_{b,ind, vorh.} / l_{b, dir, arf.}$								
Ø 10-25	3.45	3.45	3.45	3.45	3.45	3.45	3.45	3.45
Ø 10-20	4.31	4.31	4.31	4.31	4.31	4.31	4.31	4.31
Ø 10-15	5.75	5.75	5.75	5.75	5.75	5.75	5.75	5.75
Ø 10-10	8.63	8.63	8.63	8.63	8.63	8.63	8.63	8.63
Reduction of the $A_s$ values with the factor $l_{b,ind, vorh.} / l_{b, dir, arf.}$								
Ø 12-25	4.60	4.60	4.60	4.60	4.60	4.60	4.60	4.60
Ø 12-20	5.74	5.74	5.74	5.74	5.74	5.74	5.74	5.74
Ø 12-15	7.66	7.66	7.66	7.66	7.66	7.66	7.66	7.66
Ø 12-10	11.49	11.49	11.49	11.49	11.49	11.49	11.49	11.49
Reduction of the $A_s$ values with the factor $l_{b,ind, vorh.} / l_{b, dir, arf.}$								

**Non-certified translation from the German original.**

Calculation of load capacity from concrete + friction = reinforcement

$F_{cirl} = 1.1 \text{ MN/m}^2$	$F_{yd,red} = 347.8 \text{ MN/m}^2$	$v = 0.20$
Concrete quality 30 / 37	$C = 0.20$	$\mu = 0.60$
$V_{Rd,i} \text{ [kN/m]}$		
Nevoga Plexus Type A, I, M		

B	200 mm	250 mm	275 mm	300 mm	325 mm	350 mm	375 mm	400 mm	mm
Anchorage	h = 15 cm	h = 15 cm	h = 15 cm	h = 15 cm	h = 15 cm	h = 15 cm	h = 15 cm	h = 15 cm	Pull-out
∅ 8-25	118.61	129.72	135.27	140.83	146.39	151.94	157.50	163.05	L <sub>s</sub> = 320 mm
∅ 8-20	137.24	148.35	153.91	159.46	165.02	170.57	176.13	181.68	
∅ 8-15	168.05	179.16	184.72	190.27	195.83	201.38	206.94	212.49	
∅ 8-10	229.85	240.96	246.52	252.07	257.63	263.18	268.74	274.30	



B	200 mm	250 mm	275 mm	300 mm	325 mm	350 mm	375 mm	400 mm	mm
Anchorage	h = 15 cm	h = 15 cm	h = 15 cm	h = 15 cm	h = 15 cm	h = 15 cm	h = 15 cm	h = 15 cm	Pull-out
∅ 8-25	130.85	141.96	147.51	153.07	158.62	164.18	169.73	175.29	L <sub>s</sub> = 390 mm
∅ 8-20	152.45	163.56	169.11	174.67	180.22	185.78	191.33	196.89	
∅ 8-15	188.49	199.60	205.16	210.71	216.27	221.83	227.38	232.94	
∅ 8-10	260.59	271.70	277.25	282.81	288.36	293.92	299.47	305.03	



B	200 mm	250 mm	275 mm	300 mm	325 mm	350 mm	375 mm	400 mm	mm
Anchorage	h = 17 cm	h = 17 cm	h = 17 cm	h = 17 cm	h = 17 cm	h = 17 cm	h = 17 cm	h = 17 cm	Pull-out
∅ 8-25	159.52	170.63	176.19	181.75	187.30	192.86	198.41	203.97	L <sub>s</sub> = 460 mm
∅ 8-20	188.26	199.37	204.93	210.48	216.04	221.59	227.15	232.71	
∅ 8-15	236.20	247.31	252.87	258.42	263.98	269.53	275.09	280.64	
∅ 8-10	322.08	343.19	348.74	354.30	359.86	365.41	370.97	376.52	

Prüfamf für Standsicherheit  
**LGA**  
 Zweigstelle Landshut  
 S-LA of

Limitation by concrete strut (maximum value)

$F_{cirl} = 1.1 \text{ MN/m}^2$	$a_1 < 50 \text{ mm } v = 0.20$
Concrete quality 30 / 37	$C = 0.20 \quad \mu = 0.60$
$V_{Rd,i,max} \text{ [kN/m]}$	
Nevoga Plexus Type A, I, M	

B	200 mm	250 mm	275 mm	300 mm	325 mm	350 mm	375 mm	400 mm	mm
Anchorage	h = 15 cm	h = 15 cm	h = 15 cm	h = 15 cm	h = 15 cm	h = 15 cm	h = 15 cm	h = 15 cm	Pull-out
∅ 8-25	340.00	425.00	467.50	510.00	552.50	595.00	637.50	680.00	L <sub>s</sub> = 320 mm
∅ 8-20	340.00	425.00	467.50	510.00	552.50	595.00	637.50	680.00	
∅ 8-15	340.00	425.00	467.50	510.00	552.50	595.00	637.50	680.00	
∅ 8-10	340.00	425.00	467.50	510.00	552.50	595.00	637.50	680.00	



B	200 mm	250 mm	275 mm	300 mm	325 mm	350 mm	375 mm	400 mm	mm
Anchorage	h = 15 cm	h = 15 cm	h = 15 cm	h = 15 cm	h = 15 cm	h = 15 cm	h = 15 cm	h = 15 cm	Pull-out
∅ 10-25	340.00	425.00	467.50	510.00	552.50	595.00	637.50	680.00	L <sub>s</sub> = 390 mm
∅ 10-20	340.00	425.00	467.50	510.00	552.50	595.00	637.50	680.00	
∅ 10-15	340.00	425.00	467.50	510.00	552.50	595.00	637.50	680.00	
∅ 10-10	340.00	425.00	467.50	510.00	552.50	595.00	637.50	680.00	



B	200 mm	250 mm	275 mm	300 mm	325 mm	350 mm	375 mm	400 mm	mm
Anchorage	h = 17 cm	h = 17 cm	h = 17 cm	h = 17 cm	h = 17 cm	h = 17 cm	h = 17 cm	h = 17 cm	Pull-out
∅ 12-25	340.00	425.00	467.50	510.00	552.50	595.00	637.50	680.00	L <sub>s</sub> = 460 mm
∅ 12-20	340.00	425.00	467.50	510.00	552.50	595.00	637.50	680.00	
∅ 12-15	340.00	425.00	467.50	510.00	552.50	595.00	637.50	680.00	
∅ 12-10	340.00	425.00	467.50	510.00	552.50	595.00	637.50	680.00	

Prüfamt für Standsicherheit  
**LGA**  
Zweigstelle Landshut  
S-LA of

Evaluation

Assumptions: Data sheet reverse bending figure 8 b

B = Design width of wall = Wall thickness - 2a <sub>1</sub>	
a <sub>2</sub> ≥ 50 mm with surface finish smooth according to DIN EN 1992-1-1 6.2.5	
σ <sub>cd</sub> + ( ) MN/m <sup>2</sup>	A <sub>1</sub> < 50 mm v = 0.20
Concrete quality 30 / 37	C = 0.20 μ = 0.60
V <sub>Red,i</sub> [kN/m] V <sub>r,n,i</sub>	
Nevoga Plexus Type A, I, M	

B	200 mm	250 mm	275 mm	300 mm	325 mm	350 mm	375 mm	400 mm	mm
Anchorage	h = 15 cm	h = 15 cm	h = 15 cm	h = 15 cm	h = 15 cm	h = 15 cm	h = 15 cm	h = 15 cm	Pull-out
∅ 8-25	118.61	129.72	135.27	140.83	146.39	151.94	157.50	163.05	L <sub>s</sub> = 320 mm
∅ 8-20	137.24	148.35	153.91	159.46	165.02	170.57	176.13	181.68	
∅ 8-15	168.05	179.15	184.72	190.27	195.83	201.38	206.94	212.49	
∅ 8-10	229.85	240.96	246.52	252.07	257.63	263.18	268.74	274.30	



B	200 mm	250 mm	275 mm	300 mm	325 mm	350 mm	375 mm	400 mm	mm
Anchorage	h = 15 cm	h = 15 cm	h = 15 cm	h = 15 cm	h = 15 cm	h = 15 cm	h = 15 cm	h = 15 cm	Pull-out
∅ 10-25	130.85	141.96	147.51	153.07	158.62	164.18	169.73	175.29	L <sub>s</sub> = 390 mm
∅ 10-20	152.45	163.56	169.11	174.67	180.22	185.78	191.33	196.89	
∅ 10-15	188.49	199.60	205.16	210.71	216.27	221.83	227.38	232.94	
∅ 10-10	260.59	271.70	227.25	282.81	288.36	293.29	299.47	305.03	



B	200 mm	250 mm	275 mm	300 mm	325 mm	350 mm	375 mm	400 mm	mm
Anchorage	h = 17 cm	h = 17 cm	h = 17 cm	h = 17 cm	h = 17 cm	h = 17 cm	h = 17 cm	h = 17 cm	Pull-out
∅ 12-25	159.52	170.63	176.18	181.75	187.30	192.86	198.41	203.97	L <sub>s</sub> = 460 mm
∅ 12-20	188.26	199.37	204.93	210.48	216.04	221.59	227.15	232.71	
∅ 12-15	236.20	247.31	252.87	258.42	263.98	269.53	275.09	280.64	
∅ 12-10	332.08	343.19	348.30	354.30	359.88	365.41	370.97	376.52	

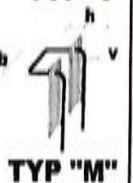

The verification of the pull-out lengths in construction section 2 must be carried out by the user!

Prüfamt für Standsicherheit  
LGA  
Zweigstelle Landshut  
S-LA of

**Non-certified translation from the German original.**

Author                  Fritsche                                                  Ingenieurbüro Program:                                      Ingenieure                                                  für Bauwesen	
Building structure : NEVOGA Plexus reinforcement connection	Date 08/2013
<p>7.      <u>Calculation of shearing force that can be absorbed Case c</u></p>          <div data-bbox="735 943 1042 1102" style="border: 1px solid black; padding: 5px; width: fit-content; margin: 0 auto;"><p>Prüfamt für Standsicherheit <b>LGA</b> Zweigstelle Landshut  S-LA                                          of</p></div>	
Component: Load capacity calculation EC 2 Block:      according to DBV data sheet 01/2011 page: 50 ..... Process:	ARCHIVE NO.:



## Non-certified translation from the German original.

Page 51

Load tables Nevoga Plexus reinforcement connections

Absorbable shearing force transverse to the concrete joint (case c) without transverse force reinforcement

$$\text{Formula 6.2a } V_{Rd,c} = c/0.5 * (C_{Rd,c} * k * (100 * \rho * f_{ck})^{1/3} = 0.12 * \sigma_{cp}) * b_x * d$$

$$\text{Equation 6.2b } V_{Rd,c} = c/0.5 * (v_{min} + 0.12 * \sigma_{cp}) * b_w * d$$

$$V_{Rd,c} = \max(6.2a; 6.2b)$$

$$\text{With } C_{Rd,c} = 0.15 / \gamma_c$$

$$= 0.1$$

$$f_{ck} = 20 \text{ MN/m}^2$$

$$v_{min} = (0.0525 / \gamma_c) * k^{3/2} * f_{ck}^{1/2} \text{ für } d \leq 600 \text{ mm}$$

$$\text{Bracket support share } V_{Rd,ct,k} = t / \tan 35^\circ * T_{rd}$$

$$V_{Rd,ct,k} = 28.17 \text{ kN/m } \varnothing 8 \text{ mm (manufacturer specification)}$$

$$V_{Rd,ct,k} = 33.81 \text{ kN/m } \varnothing 8 \text{ mm; } \varnothing 12 \text{ mm (manufacturer specification)}$$

$$\text{With } t = 30 \text{ mm } \varnothing 8 \text{ mm (manufacturer specification)}$$

$$t = 36 \text{ mm } \varnothing 8 \text{ mm; } \varnothing 12 \text{ mm (manufacturer specification)}$$

$$\alpha_{ct} = 0.85$$

$$\gamma_c = 1.5$$

$$f_{ctk,0.05} = 1.55 \text{ MN/m}^2$$

$$\text{Shearing angle} = 35^\circ \text{ bzw. } 0.61 \text{ RAD}$$

$$\text{Tan} = 0.70$$

$$T_{rd} = 0.66 \text{ MN/m}^2$$

Assumptions: Data sheet Reverse bending Case d

$$\sigma_{cp} = 0 \quad b_w = 1.0 \text{ m}$$

Concrete quality C20/25

Calculation of reinforcement degree  $P_1$  [ $10^{-3}$ ]

d=	100 mm	120 mm	140 mm	160 mm	180 mm	200 mm	220 mm	240 mm	260 mm	280 mm
k=	2	2	2	2	2	2	1.95	1.91	1.88	1.85
h=	150 mm	150 mm	150 mm	150 mm	150 mm	150 mm	150 mm	150 mm	150 mm	150 mm

$\emptyset$ – Partition [mm]										
8 - 250	0.00201	0.00168	0.00144	0.00126	0.00112	0.00101	0.00091	0.00084	0.00077	0.00072
8 – 200	0.00251	0.00209	0.0018	0.00157	0.0014	0.00126	0.00114	0.00105	0.00097	0.0009
8 – 150	0.00335	0.00279	0.00239	0.00209	0.00186	0.00168	0.00152	0.0014	0.00129	0.0012
8 – 100	0.00503	0.00419	0.00359	0.00314	0.00279	0.00251	0.00228	0.00209	0.00193	0.0018

10 - 250	0.00314	0.00262	0.00224	0.00196	0.00175	0.00157	0.00143	0.00131	0.00121	0.00112
10 – 200	0.00393	0.00327	0.0028	0.00245	0.00218	0.00196	0.01780	0.00164	0.00151	0.0014
10 – 150	0.00524	0.00436	0.00374	0.00327	0.00291	0.00262	0.00238	0.00218	0.00201	0.00187
10 – 100	0.00785	0.00654	0.00561	0.00491	0.00436	0.00393	0.00357	0.00327	0.00320	0.0028

12 - 250	0.00452	0.00377	0.00323	0.00283	0.00251	0.00226	0.00205	0.00188	0.00174	0.00162
12 – 200	0.00565	0.00471	0.00404	0.00353	0.00314	0.00283	0.00257	0.00236	0.00217	0.00202
12 – 150	0.00754	0.00628	0.00539	0.00471	0.00419	0.00377	0.00343	0.00314	0.0029	0.00269
12 – 100	0.01131	0.00942	0.00808	0.00707	0.00628	0.00565	0.00514	0.00471	0.00435	0.00404

[www.nevoga.de](http://www.nevoga.de)  
NEVOGA GmbH – Znaimer Str. 4 – D-83395 Freilassing – Telephone: 0049/8654/47310 – Fax: 0049/8654/4731 - 18

Prüfamt für Standsicherheit  
**LGA**  
Zweigstelle Landshut  
S-LA of

Calculation  $V_{Rd,c}$  [without console contact ratio] [kN/m]

d=	100 mm	120 mm	140 mm	160 mm	180 mm	200 mm	220 mm	240 mm	260 mm	280 mm
k=	2	2	2	2	2	2	1.95	1.91	1.88	1.85
$V_{Rd,c,min}$	17.71 kN/m	21.25 kN/m	24.79 kN/m	28.33 kN/m	31.88 kN/m	35.42 kN/m	37.61 kN/m	39.75 kN/m	41.86 kN/m	43.94 kN/m

h=	150 mm	150 mm	150 mm	150 mm	150 mm	150 mm	150 mm	150 mm	150 mm	150 mm
Ø – Partition [mm]										
8 - 250	17.71	21.25	24.79	28.33	31.88	35.42	37.61	39.75	41.86	43.94
8 – 200	17.71	21.25	24.79	28.33	31.88	35.42	37.61	39.75	41.86	43.94
8 – 150	17.71	21.25	24.79	28.33	31.88	35.42	37.61	39.75	41.86	43.94
8 – 100	17.71	21.25	24.79	28.33	31.88	35.42	37.61	39.75	41.86	43.94

h=	150 mm	150 mm	150 mm	150 mm	150 mm	150 mm	150 mm	150 mm	150 mm	150 mm
10 - 250	17.71	21.25	24.79	28.33	31.88	35.42	37.61	39.75	41.86	43.94
10 – 200	17.71	21.25	24.79	28.33	31.88	35.42	37.61	39.75	41.86	43.94
10 – 150	17.71	21.25	24.79	28.33	31.88	35.42	37.61	39.75	41.86	43.94
10 – 100	20.04	22.62	25.07	28.33	31.88	35.42	37.61	39.75	41.86	43.94

h=	170 mm	170 mm	170 mm	170 mm	170 mm	170 mm	170 mm	170 mm	170 mm	170 mm
12 - 250	17.71	21.25	24.79	28.33	31.88	35.42	37.61	39.75	41.86	43.94
12 – 200	17.96	21.25	24.79	28.33	31.88	35.42	37.61	39.75	41.86	43.94
12 – 150	19.76	23.32	24.79	28.33	31.88	35.42	37.61	39.75	41.86	43.94
12 – 100	22.62	25.55	28.31	30.95	33.48	35.91	37.61	39.75	41.86	43.94

[www.nevoga.de](http://www.nevoga.de)  
NEVOGA GmbH – Znaimer Str. 4 – D-83395 Freilassing – Telephone: 0049/8654/47310 – Fax: 0049/8654/4731 - 18

Prüfamt für Standsicherheit  
**LGA**  
Zweigstelle Landshut  
S-LA of

Calculation  $V_{Rd,c}$  [with console contact ratio] [kN/m]

d=	100 mm	120 mm	140 mm	160 mm	180 mm	200 mm	220 mm	240 mm	260 mm	280 mm
k=	2	2	2	2	2	2	1.95	1.91	1.88	1.85

h=	150 mm	150 mm	150 mm	150 mm	150 mm	150 mm	150 mm	150 mm	150 mm	150 mm
∅ – Partition [mm]										
8 - 250	45.88	49.42	52.97	56.51	60.05	63.59	65.78	67.93	70.04	72.11
8 - 200	45.88	49.42	52.97	56.51	60.05	63.59	65.78	67.93	70.04	72.11
8 - 150	45.88	49.42	52.97	56.51	60.05	63.59	65.78	67.93	70.04	72.11
8 - 100	45.88	49.42	52.97	56.51	60.05	63.59	65.78	67.93	70.04	72.11

h=	150 mm	150 mm	150 mm	150 mm	150 mm	150 mm	150 mm	150 mm	150 mm	150 mm
10 - 250	51.52	55.06	58.60	62.14	65.69	69.23	71.42	73.56	75.67	77.75
10 - 200	51.52	55.06	58.60	62.14	65.69	69.23	71.42	73.56	75.67	77.75
10 - 150	51.52	55.06	58.60	62.14	65.69	69.23	71.42	73.56	75.67	77.75
10 - 100	53.84	56.43	58.88	62.14	65.69	69.23	71.42	73.56	75.67	77.75

h=	170 mm	170 mm	170 mm	170 mm	170 mm	170 mm	170 mm	170 mm	170 mm	170 mm
12 - 250	51.52	55.06	58.60	62.14	65.69	69.23	71.42	73.56	75.67	77.75
12 - 200	51.77	55.06	58.60	62.14	65.69	69.23	71.42	73.56	75.67	77.75
12 - 150	53.57	56.13	58.60	62.14	65.69	69.23	71.42	73.56	75.67	77.75
12 - 100	56.43	59.36	62.12	64.76	67.29	69.72	71.42	73.56	75.67	77.75

[www.nevoga.de](http://www.nevoga.de)  
NEVOGA GmbH – Znaimer Str. 4 – D-83395 Freilassing – Telephone: 0049/8654/47310 – Fax: 0049/8654/4731 - 18

Prüfamt für Standsicherheit  
**LGA**  
Zweigstelle Landshut  
S-LA of

Calculation  $V_{Rd,max}$  [upper limit value] [kN/m]

d=	100 mm	120 mm	140 mm	160 mm	180 mm	200 mm	220 mm	240 mm	260 mm	280 mm
k=	2	2	2	2	2	2	1.95	1.91	1.88	1.85
$V_{Rd,c,min}$	44.27 kN/m	53.13 kN/m	61.98 kN/m	70.84 kN/m	79.69 kN/m	88.54 kN/m	94.02 kN/m	99.39 kN/m	104.66 kN/m	109.85 kN/m

h=	150 mm	150 mm	150 mm	150 mm	150 mm	150 mm	150 mm	150 mm	150 mm	150 mm
$\emptyset$ – Partition [mm]										
8 - 250	44.27	53.13	61.98	70.84	79.69	88.54	94.02	99.39	104.66	109.85
8 – 200	44.27	53.13	61.98	70.84	79.69	88.54	94.02	99.39	104.66	109.85
8 – 150	44.27	53.13	61.98	70.84	79.69	88.54	94.02	99.39	104.66	109.85
8 – 100	44.27	53.13	61.98	70.84	79.69	88.54	94.02	99.39	104.66	109.85

h=	150 mm	150 mm	150 mm	150 mm	150 mm	150 mm	150 mm	150 mm	150 mm	150 mm
10 - 250	44.27	53.13	61.98	70.84	79.69	88.54	94.02	99.39	104.66	109.85
10 – 200	44.27	53.13	61.98	70.84	79.69	88.54	94.02	99.39	104.66	109.85
10 – 150	44.27	53.13	61.98	70.84	79.69	88.54	94.02	99.39	104.66	109.85
10 – 100	50.09	56.56	62.68	70.84	79.69	88.54	94.02	99.39	104.66	109.85

h=	170 mm	170 mm	170 mm	170 mm	170 mm	170 mm	170 mm	170 mm	170 mm	170 mm
12 - 250	44.27	53.13	61.98	70.84	79.69	88.54	94.02	99.39	104.66	109.85
12 – 200	44.89	53.13	61.98	70.84	79.69	88.54	94.02	99.39	104.66	109.85
12 – 150	49.41	55.80	61.98	70.84	79.69	88.54	94.02	99.39	104.66	109.85
12 – 100	56.56	53.87	70.79	77.38	83.70	89.79	94.02	99.39	104.66	109.85

[www.nevoga.de](http://www.nevoga.de)

NEVOGA GmbH – Znaimer Str. 4 – D-83395 Freilassing – Telephone: 0049/8654/47310 – Fax: 0049/8654/4731 - 18

Prüfamt für Standsicherheit  
**LGA**  
Zweigstelle Landshut

S-LA

of

Calculation  $V_{Rd,c}$  [Adjustment of upper limit value] [kN/m]

d=	100 mm	120 mm	140 mm	160 mm	180 mm	200 mm	220 mm	240 mm	260 mm	280 mm
----	--------	--------	--------	--------	--------	--------	--------	--------	--------	--------

h=	150 mm	150 mm	150 mm	150 mm	150 mm	150 mm	150 mm	150 mm	150 mm	150 mm
----	--------	--------	--------	--------	--------	--------	--------	--------	--------	--------

Ø – Partition [mm]										
8 - 250	44.27	49.42	52.97	56.51	60.05	63.59	65.78	67.93	70.04	72.11
8 - 200	44.27	49.42	52.97	56.51	60.05	63.59	65.78	67.93	70.04	72.11
8 - 150	44.27	49.42	52.97	56.51	60.05	63.59	65.78	67.93	70.04	72.11
8 - 100	44.27	49.42	52.97	56.51	60.05	63.59	65.78	67.93	70.04	72.11

h=	150 mm	150 mm	150 mm	150 mm	150 mm	150 mm	150 mm	150 mm	150 mm	150 mm
10 - 250	44.27	53.13	58.60	62.14	65.69	69.23	71.42	73.56	75.67	77.75
10 - 200	44.27	53.13	58.60	62.14	65.69	69.23	71.42	73.56	75.67	77.75
10 - 150	44.27	53.13	58.60	62.14	65.69	69.23	71.42	73.56	75.67	77.75
10 - 100	50.09	56.43	58.88	62.14	65.69	69.23	71.42	73.56	75.67	77.75

h=	170 mm	170 mm	170 mm	170 mm	170 mm	170 mm	170 mm	170 mm	170 mm	170 mm
12 - 250	44.27	53.13	58.60	62.14	65.69	69.23	71.42	73.56	75.67	77.75
12 - 200	44.89	53.13	58.60	62.14	65.69	69.23	71.42	73.56	75.67	77.75
12 - 150	49.41	55.80	58.60	62.14	65.69	69.23	71.42	73.56	75.67	77.75
12 - 100	56.43	59.36	62.12	64.76	67.29	69.72	71.42	73.56	75.67	77.75

[www.nevoga.de](http://www.nevoga.de)  
NEVOGA GmbH – Znaimer Str. 4 – D-83395 Freilassing – Telephone: 0049/8654/47310 – Fax: 0049/8654/4731 - 18

Prüfamt für Standsicherheit  
**LGA**  
Zweigstelle Landshut  
S-LA of

Calculation rec.  $L_b$  [mm]

d=	100 mm	120 mm	140 mm	160 mm	180 mm	200 mm	220 mm	240 mm	260 mm	280 mm
----	--------	--------	--------	--------	--------	--------	--------	--------	--------	--------

h=	150 mm	150 mm	150 mm	150 mm	150 mm	150 mm	150 mm	150 mm	150 mm	150 mm
----	--------	--------	--------	--------	--------	--------	--------	--------	--------	--------

Ø – Partition [mm]										
8 - 250	148	165	177	188	200	212	219	226	233	240
8 – 200	118	132	141	151	160	170	175	181	187	192
8 – 150	89	99	106	113	120	127	132	136	140	144
8 – 100	80	80	80	80	80	85	88	91	93	96

h=	150 mm	150 mm	150 mm	150 mm	150 mm	150 mm	150 mm	150 mm	150 mm	150 mm
10 - 250	118	142	156	166	175	186	190	196	202	207
10 – 200	100	113	125	133	140	148	152	157	161	166
10 – 150	100	100	100	100	105	111	114	118	121	124
10 – 100	100	100	100	100	100	100	100	100	100	100

h=	170 mm	170 mm	170 mm	170 mm	170 mm	170 mm	170 mm	170 mm	170 mm	170 mm
12 - 250	120	120	130	138	146	154	159	163	168	173
12 – 200	120	120	120	120	120	123	127	131	135	138
12 – 150	120	120	120	120	120	120	120	120	120	120
12 – 100	120	120	120	120	120	120	120	120	120	120

[www.nevoga.de](http://www.nevoga.de)  
NEVOGA GmbH – Znaimer Str. 4 – D-83395 Freilassing – Telephone: 0049/8654/47310 – Fax: 0049/8654/4731 - 18

Prüfamt für Standsicherheit  
**LGA**  
Zweigstelle Landshut  
S-LA of

**Non-certified translation from the German original.**

Result  $V_{Rd,c}$  [kN/m] Concrete quality C20/25 Transverse force vertical - Case c Data sheet Reverse bending acc. to EC, Figure 8  
Nevoga Plexus Type B

d=	100 mm	120 mm	140 mm	160 mm	180 mm	200 mm	220 mm	240 mm	260 mm	280 mm
----	--------	--------	--------	--------	--------	--------	--------	--------	--------	--------

h=	150 mm	150 mm	150 mm	150 mm	150 mm	150 mm	150 mm	150 mm	150 mm	150 mm
Ø – Partition [mm]										
8 - 250	44.27	45.00	45.00	45.00	45.00	45.00	45.00	45.00	45.00	45.00
8 – 200	44.27	49.42	52.97	56.25	56.25	56.25	56.25	56.25	56.25	56.25
8 – 150	44.27	49.42	52.97	56.51	60.05	63.59	65.78	67.93	70.04	72.11
8 – 100	44.27	49.42	52.97	56.51	60.05	63.59	65.78	67.93	70.04	72.11

h=	150 mm	150 mm	150 mm	150 mm	150 mm	150 mm	150 mm	150 mm	150 mm	150 mm
10 - 250	44.27	53.13	56.25	56.25	56.25	56.25	56.25	56.25	56.25	56.25
10 – 200	44.27	53.13	58.60	62.14	65.69	69.23	70.31	70.31	70.31	70.31
10 – 150	44.27	53.13	58.60	62.14	65.69	69.23	71.42	73.56	75.67	77.75
10 – 100	50.09	53.13	58.88	62.14	65.69	69.23	71.42	73.56	75.67	77.75

h=	170 mm	170 mm	170 mm	170 mm	170 mm	170 mm	170 mm	170 mm	170 mm	170 mm
12 - 250	Production technically not possible	53.13	58.60	62.14	65.69	69.23	71.42	73.56	75.67	76.50
12 – 200		53.13	58.60	62.14	65.69	69.23	71.42	73.56	75.67	77.75
12 – 150		55.80	58.60	62.14	65.69	69.23	71.42	73.56	75.67	77.75
12 – 100		59.36	62.12	64.76	67.29	69.72	71.42	73.56	75.67	77.75

The verification of the pull-out lengths in construction section 2 must be carried out by the user!  
The tensile force cover must be verified by the user in the pull-out area of the reverse bend connection!  
According to DIN EN 1992-1-1, section 9.3.1.2, paragraph (1), at least half of the field reinforcement of solid slabs must be guided to the support and anchored there!

[www.nevoga.de](http://www.nevoga.de)  
NEVOGA GmbH – Znaimer Str. 4 – D-83395 Freilassing – Telephone: 0049/8654/47310 – Fax: 0049/8654/4731 - 18

Prüfamt für Standsicherheit  
**LGA**  
Zweigstelle Landshut  
S-LA of



## Non-certified translation from the German original.

(Page 59)

Load tables Nevoga Plexus reinforcement connections

Absorbable shearing force transverse to the concrete joint (case c) with transverse force reinforcement

$$\text{Equation 6.8} \quad V_{Rd,s} = A_{sw} / S) * z * f_{ywd} * \cot\Theta$$

$$\text{Equation 6.9} \quad V_{Rd,max} = 0.3 * b_w * z * v_1 * f_{cd} / \cot\Theta + \tan\Theta$$

$$V_{Rd,c} = \min(6.8, 6.9)$$

$$\text{With} \quad V_1 = 0.75 * (1.1 - f_{ck}/500) \leq 0.75$$

$$= 0.75$$

$$f_{ck} = 20 \quad \text{MN/m}^2$$

$$f_{yk} = 500 \quad \text{MN/m}^2$$

$$\gamma_c = 1.5$$

$$f_{ck,0.05} = 1.55 \text{ MN/m}^2$$

Assumptions: Data sheet Reverse bending Case c

$$\sigma_{cp} = 0 \quad b_w = 1.0 \text{ m}$$

Concrete quality C20/25

**Non-certified translation from the German original.**

Calculation  $V_{Rd,max}$  [kN/m]

d=	140 mm	160 mm	180 mm	200 mm	220 mm	240 mm	260 mm	280 mm
z=	75	95	115	135	155	175	195	215

h=	150 mm	150 mm	150 mm	150 mm	150 mm	150 mm	150 mm	150 mm
∅ – Partition [mm]								
8 - 250	94.06	119.14	144.22	169.30	194.39	219.47	244.55	269.63
8 - 200	94.06	119.14	144.22	169.30	194.39	219.47	244.55	269.63
8 - 150	94.06	119.14	144.22	169.30	194.39	219.47	244.55	269.63
8 - 100	94.06	119.14	144.22	169.30	194.39	219.47	244.55	269.63

h=	150 mm	150 mm	150 mm	150 mm	150 mm	150 mm	150 mm	150 mm
10 - 250	94.06	119.14	144.22	169.30	194.39	219.47	244.55	269.63
10 - 200	94.06	119.14	144.22	169.30	194.39	219.47	244.55	269.63
10 - 150	94.06	119.14	144.22	169.30	194.39	219.47	244.55	269.63
10 - 100	94.06	119.14	144.22	169.30	194.39	219.47	244.55	269.63

h=	170 mm	170 mm	170 mm	170 mm	170 mm	170 mm	170 mm	170 mm
12 - 250	94.06	119.14	144.22	169.30	194.39	219.47	244.55	269.63
12 - 200	94.06	119.14	144.22	169.30	194.39	219.47	244.55	269.63
12 - 150	94.06	119.14	144.22	169.30	194.39	219.47	244.55	269.63
12 - 100	94.06	119.14	144.22	169.30	194.39	219.47	244.55	269.63

[www.nevoga.de](http://www.nevoga.de)  
NEVOGA GmbH – Znaimer Str. 4 – D-83395 Freilassing – Telephone: 0049/8654/47310 – Fax: 0049/8654/4731 - 18

Prüfamt für Standsicherheit  
**LGA**  
Zweigstelle Landshut  
S-LA of

Calculation rec.  $L_b$  [mm]

d=	140 mm	160 mm	180 mm	200 mm	220 mm	240 mm	260 mm	280 mm
----	--------	--------	--------	--------	--------	--------	--------	--------

h=	150 mm	150 mm	150 mm	150 mm	150 mm	150 mm	150 mm	150 mm
----	--------	--------	--------	--------	--------	--------	--------	--------

Ø – Partition [mm]								
8 - 250	169	214	260	305	350	395	440	485
8 - 200	135	172	208	244	280	316	352	388
8 - 150	102	129	156	183	210	237	264	291
8 - 100	80	86	104	122	140	158	176	194

h=	150 mm	150 mm	150 mm	150 mm	150 mm	150 mm	150 mm	150 mm
10 - 250	135	172	208	244	280	316	352	388
10 - 200	108	137	166	195	224	253	282	311
10 - 150	100	102	125	146	168	190	211	233
10 - 100	100	100	100	100	112	126	141	155

h=	170 mm	170 mm	170 mm	170 mm	170 mm	170 mm	170 mm	170 mm
12 - 250	120	143	173	203	233	263	293	324
12 - 200	120	120	138	163	187	211	235	259
12 - 150	120	120	120	122	140	158	176	194
12 - 100	120	120	120	120	120	120	120	129

[www.nevoga.de](http://www.nevoga.de)  
NEVOGA GmbH – Znaimer Str. 4 – D-83395 Freilassing – Telephone: 0049/8654/47310 – Fax: 0049/8654/4731 - 18

Prüfamt für Standsicherheit  
**LGA**  
Zweigstelle Landshut  
S-LA of

**Non-certified translation from the German original.**

Result  $V_{Rd,c}$  [kN/m] Concrete quality C20/25 with transverse force reinforcement  
Transverse force vertical - Case c Data sheet Reverse bending according to EC, Figure 8  
Nevoga Plexus Type B

d=	140 mm	160 mm	180 mm	200 mm	220 mm	240 mm	260 mm	280 mm
----	--------	--------	--------	--------	--------	--------	--------	--------

h=	150 mm	150 mm	150 mm	150 mm	150 mm	150 mm	150 mm	150 mm
----	--------	--------	--------	--------	--------	--------	--------	--------

∅ – Partition [mm]								
8 - 250	83.33	83.33	83.33	83.33	83.33	83.33	83.33	83.33
8 - 200	94.06	104.16	104.16	104.16	104.16	104.16	104.16	104.16
8 - 150	94.06	119.14	138.88	138.88	138.88	138.88	138.88	138.88
8 - 100	94.06	119.14	144.22	169.30	194.39	208.33	208.33	208.33

h=	150 mm	150 mm	150 mm	150 mm	150 mm	150 mm	150 mm	150 mm
10 - 250	94.06	119.14	104.16	104.16	104.16	104.16	104.16	104.16
10 - 200	94.06	119.14	130.20	130.20	130.20	130.20	130.20	130.20
10 - 150	94.06	119.14	144.22	169.30	173.61	173.61	173.61	173.61
10 - 100	94.06	119.14	144.22	169.30	194.39	219.47	244.55	260.41

h=	170 mm	170 mm	170 mm	170 mm	170 mm	170 mm	170 mm	170 mm
12 - 250	94.06	119.14	141.66	141.66	141.66	141.66	141.66	141.66
12 - 200	94.06	119.14	144.22	169.30	177.08	177.08	177.08	177.08
12 - 150	94.06	119.14	144.22	169.30	194.39	219.47	236.10	236.10
12 - 100	94.06	119.14	144.22	169.30	194.39	219.47	244.55	269.63

The required transverse force reinforcement for vertical stirrups shall be calculated assuming  $\cot \theta = 1$  according to the following equation:  $\text{erf. } a_{sw} = V_{ed} / (f_{ywd} * z)$

The verification of the pull-out lengths in construction section 2 must be carried out by the user!

The tensile force cover must be verified by the user in the pull-out area of the reverse bend connection!

According to DIN EN 1992-1-1, section 9.3.1.2, paragraph (1), at least half of the field reinforcement of solid slabs must be guided to the support and anchored there!

According to DIN EN 1992-1-1, section 9.3.2 (1), the minimum thicknesses of the solid slabs for the arrangement of a transverse force reinforcement must be observed!

[www.nevoga.de](http://www.nevoga.de)  
NEVOGA GmbH – Znaimer Str. 4 – D-83395 Freilassing – Telephone: 0049/8654/47310 – Fax: 0049/8654/4731 – 18



Prüfamt für  
Standicherheit  
LGA  
Zweigstelle Landshut  
S-LA of

## Non-certified translation from the German original.

Page 63

Load tables Nevoga Plexus reinforcement connections

Absorbable shearing force transverse to the concrete joint (case c) without transverse force reinforcement

$$\text{Formula 6.2a } V_{Rd,c} = c/0.5 * (C_{Rd,c} * k * (100 * \rho * f_{ck})^{1/3} = 0.12 * \sigma_{cp}) * b_x * d$$

$$\text{Equation 6.2b } V_{Rd,c} = c/0.5 * (v_{min} + 0.12 * \sigma_{cp}) * b_w * d$$

$$V_{Rd,c} = \max(6.2a; 6.2b)$$

$$\text{With } C_{Rd,c} = 0.15 / \gamma_c$$

$$= 0.1$$

$$f_{ck} = 25 \text{ MN/m}^2$$

$$v_{min} = (0.0525 / \gamma_c) * k^{3/2} * f_{ck}^{1/2} \text{ für } d \leq 600 \text{ mm}$$

$$\text{Bracket support share } V_{Rd,ct,k} = t / \tan 35^\circ * T_{rd}$$

$$V_{Rd,ct,k} = 32.69 \text{ kN/m } \varnothing 8 \text{ mm (manufacturer specification)}$$

$$V_{Rd,ct,k} = 39.23 \text{ kN/m } \varnothing 8 \text{ mm; } \varnothing 12 \text{ mm (manufacturer specification)}$$

$$\text{With } t = 30 \text{ mm } \varnothing 8 \text{ mm (manufacturer specification)}$$

$$t = 36 \text{ mm } \varnothing 8 \text{ mm; } \varnothing 12 \text{ mm (manufacturer specification)}$$

$$\alpha_{ct} = 0.85$$

$$\gamma_c = 1.5$$

$$f_{ctk,0.05} = 1.80 \text{ m}$$

$$\text{Shearing angle} = 35^\circ \text{ bzw. } 0.61 \text{ RAD}$$

$$\text{Tan} = 0.70$$

$$T_{rd} = 0.76 \text{ MN/m}^2$$

Assumptions: Data sheet Reverse bending Case d

$$\sigma_{cp} = 0 \quad b_w = 1.0 \text{ m}$$

Concrete quality C25/30

Calculation of reinforcement degree  $P_1$  [ $10^{-3}$ ]

d=	100 mm	120 mm	140 mm	160 mm	180 mm	200 mm	220 mm	240 mm	260 mm	280 mm
k=	2	2	2	2	2	2	1.95	1.91	1.88	1.85
h=	150 mm	150 mm	150 mm	150 mm	150 mm	150 mm	150 mm	150 mm	150 mm	150 mm

$\emptyset$ - Partition [mm]										
8 - 250	0.00201	0.00168	0.00144	0.00126	0.00112	0.00101	0.00091	0.00084	0.00077	0.00072
8 - 200	0.00251	0.00209	0.0018	0.00157	0.0014	0.00126	0.00114	0.00105	0.00097	0.0009
8 - 150	0.00335	0.00279	0.00239	0.00209	0.00186	0.00168	0.00152	0.0014	0.00129	0.0012
8 - 100	0.00503	0.00419	0.00359	0.00314	0.00279	0.00251	0.00228	0.00209	0.00193	0.0018

10 - 250	0.00314	0.00262	0.00224	0.00196	0.00175	0.00157	0.00143	0.00131	0.00121	0.00112
10 - 200	0.00393	0.00327	0.0028	0.00245	0.00218	0.00196	0.01780	0.00164	0.00151	0.0014
10 - 150	0.00524	0.00436	0.00374	0.00327	0.00291	0.00262	0.00238	0.00218	0.00201	0.00187
10 - 100	0.00785	0.00654	0.00561	0.00491	0.00436	0.00393	0.00357	0.00327	0.00302	0.0028

12 - 250	0.00452	0.00377	0.00323	0.00283	0.00251	0.00226	0.00206	0.00188	0.00174	0.00162
12 - 200	0.00565	0.00471	0.00404	0.00353	0.00314	0.00283	0.00257	0.00236	0.00217	0.00202
12 - 150	0.00754	0.00628	0.00539	0.00471	0.00419	0.00377	0.00343	0.00314	0.0029	0.00269
12 - 100	0.01131	0.00942	0.00808	0.00707	0.00628	0.00565	0.00514	0.00471	0.00435	0.00404

[www.nevoga.de](http://www.nevoga.de)  
NEVOGA GmbH – Znaimer Str. 4 – D-83395 Freilassing – Telephone: 0049/8654/47310 – Fax: 0049/8654/4731 - 18

Prüfamt für Standsicherheit  
**LGA**  
Zweigstelle Landshut  
S-LA of

Calculation  $V_{Rd,c}$  [without console contact ratio] [kN/m]

d=	100 mm	120 mm	140 mm	160 mm	180 mm	200 mm	220 mm	240 mm	260 mm	280 mm
k=	2	2	2	2	2	2	1.95	1.91	1.88	1.85
$V_{Rd,c,min}$	19.80 kN/m	23.76 kN/m	27.72 kN/m	31.68 kN/m	35.64 kN/m	39.69 kN/m	42.05 kN/m	44.45 kN/m	45.80 kN/m	49.13 kN/m

h=	150 mm	150 mm	150 mm	150 mm	150 mm	150 mm	150 mm	150 mm	150 mm	150 mm
Ø – Partition [mm]										
8 - 250	19.80	23.75	27.72	31.68	35.64	39.60	42.05	44.45	46.80	49.13
8 - 200	19.80	23.75	27.72	31.68	35.64	39.60	42.05	44.45	46.80	49.13
8 - 150	19.80	23.75	27.72	31.68	35.64	39.60	42.05	44.45	46.80	49.13
8 - 100	19.80	23.75	27.72	31.68	35.64	39.60	42.05	44.45	46.80	49.13

h=	150 mm	150 mm	150 mm	150 mm	150 mm	150 mm	150 mm	150 mm	150 mm	150 mm
10 - 250	19.80	23.75	27.72	31.68	35.64	39.60	42.05	44.45	46.80	49.13
10 - 200	19.80	23.75	27.72	31.68	35.64	39.60	42.05	44.45	46.80	49.13
10 - 150	19.80	23.75	27.72	31.68	35.64	39.60	42.05	44.45	46.80	49.13
10 - 100	19.80	23.75	27.72	31.68	35.64	39.60	42.05	44.45	46.80	49.13

h=	170 mm	170 mm	170 mm	170 mm	170 mm	170 mm	170 mm	170 mm	170 mm	170 mm
12 - 250	19.80	23.75	27.72	31.68	35.64	39.60	42.05	44.45	46.80	49.13
12 - 200	19.80	23.75	27.72	31.68	35.64	39.60	42.05	44.45	46.80	49.13
12 - 150	21.29	24.04	27.72	31.68	35.64	39.60	42.05	44.45	46.80	49.13
12 - 100	24.37	27.52	30.50	33.34	33.06	39.60	42.05	44.45	46.80	49.13

[www.nevoga.de](http://www.nevoga.de)  
NEVOGA GmbH – Znaimer Str. 4 – D-83395 Freilassing – Telephone: 0049/8654/47310 – Fax: 0049/8654/4731 - 18

Prüfamt für Standsicherheit  
**LGA**  
Zweigstelle Landshut  
S-LA of

Calculation  $V_{Rd,c}$  [without console contact ratio] [kN/m]

d=	100 mm	120 mm	140 mm	160 mm	180 mm	200 mm	220 mm	240 mm	260 mm	280 mm
k=	2	2	2	2	2	2	1.95	1.91	1.88	1.85

h=	150 mm	150 mm	150 mm	150 mm	150 mm	150 mm	150 mm	150 mm	150 mm	150 mm
∅ – Partition [mm]										
8 - 250	52.49	56.45	60.41	64.37	68.33	72.29	74.74	77.14	79.50	81.82
8 - 200	52.49	56.45	60.41	64.37	68.33	72.29	74.74	77.14	79.50	81.82
8 - 150	52.49	56.45	60.41	64.37	68.33	72.29	74.74	77.14	79.50	81.82
8 - 100	52.49	56.45	60.41	64.37	68.33	72.29	74.74	77.14	79.50	81.82

h=	150 mm	150 mm	150 mm	150 mm	150 mm	150 mm	150 mm	150 mm	150 mm	150 mm
10 - 250	59.03	62.99	66.95	70.91	74.87	78.83	81.28	83.68	86.04	88.36
10 - 200	59.03	62.99	66.95	70.91	74.87	78.83	81.28	83.68	86.04	88.36
10 - 150	59.03	62.99	66.95	70.91	74.87	78.83	81.28	83.68	86.04	88.36
10 - 100	59.03	63.60	66.95	70.91	74.87	78.83	81.28	83.68	86.04	88.36

h=	170 mm	170 mm	170 mm	170 mm	170 mm	170 mm	170 mm	170 mm	170 mm	170 mm
12 - 250	59.03	62.99	66.95	70.91	74.87	78.83	81.28	83.68	86.04	88.36
12 - 200	59.03	62.99	66.95	70.91	74.87	78.83	81.28	83.68	86.04	88.36
12 - 150	60.52	63.27	66.95	70.91	74.87	78.83	81.28	83.68	86.04	88.36
12 - 100	63.60	66.75	69.73	72.57	75.30	78.83	81.28	83.68	86.04	88.36

[www.nevoga.de](http://www.nevoga.de)  
NEVOGA GmbH – Znaimer Str. 4 – D-83395 Freilassing – Telephone: 0049/8654/47310 – Fax: 0049/8654/4731 - 18

Prüfamt für Standsicherheit  
**LGA**  
Zweigstelle Landshut  
S-LA of



Calculation  $V_{Rd,max}$  [upper limit value] [kN/m]

d=	100 mm	120 mm	140 mm	160 mm	180 mm	200 mm	220 mm	240 mm	260 mm	280 mm
k=	2	2	2	2	2	2	1.95	1.91	1.88	1.85
$V_{Rd,c,min}$	49.59 kN/m	59.40 kN/m	69.30 kN/m	79.20 kN/m	89.10 kN/m	98.99 kN/m	105.12 kN/m	111.12 kN/m	117.01 kN/m	122.81 kN/m

h=	150 mm	150 mm	150 mm	150 mm	150 mm	150 mm	150 mm	150 mm	150 mm	150 mm
Ø – Partition [mm]										
8 - 250	49.50	59.40	69.30	79.20	89.10	98.99	105.12	111.12	117.01	122.81
8 - 200	49.50	59.40	69.30	79.20	89.10	98.99	105.12	111.12	117.01	122.81
8 - 150	49.50	59.40	69.30	79.20	89.10	98.99	105.12	111.12	117.01	122.81
8 - 100	49.50	59.40	69.30	79.20	89.10	98.99	105.12	111.12	117.01	122.81

h=	150 mm	150 mm	150 mm	150 mm	150 mm	150 mm	150 mm	150 mm	150 mm	150 mm
10 - 250	49.50	59.40	69.30	79.20	89.10	98.99	105.12	111.12	117.01	122.81
10 - 200	49.50	59.40	69.30	79.20	89.10	98.99	105.12	111.12	117.01	122.81
10 - 150	49.50	59.40	69.30	79.20	89.10	98.99	105.12	111.12	117.01	122.81
10 - 100	53.96	60.93	69.30	79.20	89.10	98.99	105.12	111.12	117.01	122.81

h=	170 mm	170 mm	170 mm	170 mm	170 mm	170 mm	170 mm	170 mm	170 mm	170 mm
12 - 250	49.50	59.40	69.30	79.20	89.10	98.99	105.12	111.12	117.01	122.81
12 - 200	49.50	59.40	69.30	79.20	89.10	98.99	105.12	111.12	117.01	122.81
12 - 150	52.23	60.11	69.30	79.20	89.10	98.99	105.12	111.12	117.01	122.81
12 - 100	60.93	68.80	76.25	83.85	90.16	98.99	105.12	111.12	117.01	122.81

[www.nevoga.de](http://www.nevoga.de)  
NEVOGA GmbH – Znaimer Str. 4 – D-83395 Freilassing – Telephone: 0049/8654/47310 – Fax: 0049/8654/4731 - 18

Prüfamt für Standsicherheit  
**LGA**  
Zweigstelle Landshut  
S-LA of

Calculation  $V_{Rd,c}$  [Adjustment of upper limit value] [kN/m]

d=	100 mm	120 mm	140 mm	160 mm	180 mm	200 mm	220 mm	240 mm	260 mm	280 mm
----	--------	--------	--------	--------	--------	--------	--------	--------	--------	--------

h=	150 mm	150 mm	150 mm	150 mm	150 mm	150 mm	150 mm	150 mm	150 mm	150 mm
----	--------	--------	--------	--------	--------	--------	--------	--------	--------	--------

Ø – Partition [mm]										
8 - 250	49.50	56.45	60.41	64.37	68.33	72.29	74.74	77.14	79.50	81.82
8 - 200	49.50	56.45	60.41	64.37	68.33	72.29	74.74	77.14	79.50	81.82
8 - 150	49.50	56.45	60.41	64.37	68.33	72.29	74.74	77.14	79.50	81.82
8 - 100	49.50	56.45	60.41	64.37	68.33	72.29	74.74	77.14	79.50	81.82

h=	150 mm	150 mm	150 mm	150 mm	150 mm	150 mm	150 mm	150 mm	150 mm	150 mm
10 - 250	49.50	59.49	66.95	70.91	74.87	78.83	81.28	83.68	86.04	88.36
10 - 200	49.50	59.49	66.95	70.91	74.87	78.83	81.28	83.68	86.04	88.36
10 - 150	49.50	59.49	66.95	70.91	74.87	78.83	81.28	83.68	86.04	88.36
10 - 100	53.96	60.93	66.95	70.91	74.87	78.83	81.28	83.68	86.04	88.36

h=	170 mm	170 mm	170 mm	170 mm	170 mm	170 mm	170 mm	170 mm	170 mm	170 mm
12 - 250	49.50	59.49	66.95	70.91	74.87	78.83	81.28	83.68	86.04	88.36
12 - 200	49.50	59.49	66.95	70.91	74.87	78.83	81.28	83.68	86.04	88.36
12 - 150	52.23	60.11	66.95	70.91	74.87	78.83	81.28	83.68	86.04	88.36
12 - 100	60.93	66.75	69.73	72.57	75.30	78.83	81.28	83.68	86.04	88.36

[www.nevoga.de](http://www.nevoga.de)  
NEVOGA GmbH – Znaimer Str. 4 – D-83395 Freilassing – Telephone: 0049/8654/47310 – Fax: 0049/8654/4731 - 18

Prüfamt für Standsicherheit  
**LGA**  
Zweigstelle Landshut  
S-LA of

Calculation rec.  $L_b$  [mm]

d=	100 mm	120 mm	140 mm	160 mm	180 mm	200 mm	220 mm	240 mm	260 mm	280 mm
----	--------	--------	--------	--------	--------	--------	--------	--------	--------	--------

h=	150 mm	150 mm	150 mm	150 mm	150 mm	150 mm	150 mm	150 mm	150 mm	150 mm
Ø – Partition [mm]										
8 - 250	142	162	174	185	196	208	215	222	228	235
8 - 200	114	130	139	148	157	166	172	177	183	188
8 - 150	85	97	104	111	118	125	129	133	137	141
8 - 100	80	80	80	80	80	83	86	89	91	94

h=	150 mm	150 mm	150 mm	150 mm	150 mm	150 mm	150 mm	150 mm	150 mm	150 mm
10 - 250	114	137	154	163	172	181	187	192	198	203
10 - 200	100	109	123	130	138	145	149	154	158	162
10 - 150	100	100	100	100	103	109	112	115	119	122
10 - 100	100	100	100	100	100	100	100	100	100	100

h=	170 mm	170 mm	170 mm	170 mm	170 mm	170 mm	170 mm	170 mm	170 mm	170 mm
12 - 250	120	120	128	136	143	151	156	160	165	169
12 - 200	120	120	120	120	120	121	125	128	132	135
12 - 150	120	120	120	120	120	120	120	120	120	120
12 - 100	120	120	120	120	120	120	120	120	120	120

[www.nevoga.de](http://www.nevoga.de)  
NEVOGA GmbH – Znaimer Str. 4 – D-83395 Freilassing – Telephone: 0049/8654/47310 – Fax: 0049/8654/4731 - 18

Prüfamt für Standsicherheit  
**LGA**  
Zweigstelle Landshut  
S-LA of

**Non-certified translation from the German original.**

Result  $V_{Rd}$  [kN/m] Concrete quality C20/25 Transverse force vertical - Case c Data sheet Reverse bending acc. to EC, Figure 8  
The requirements for consideration of the bracket support component in accordance with DBV data sheet Section 5.3 (6) shall be met.

Nevoga Plexus Type B

d=	100 mm	120 mm	140 mm	160 mm	180 mm	200 mm	220 mm	240 mm	260 mm	280 mm
----	--------	--------	--------	--------	--------	--------	--------	--------	--------	--------

h=	150 mm	150 mm	150 mm	150 mm	150 mm	150 mm	150 mm	150 mm	150 mm	150 mm
----	--------	--------	--------	--------	--------	--------	--------	--------	--------	--------

Ø – Partition [mm]										
8 - 250	49.50	52.22	52.22	52.22	52.22	52.22	52.22	52.22	52.22	52.22
8 – 200	49.50	56.45	60.41	64.37	65.27	65.27	65.27	65.27	65.27	65.27
8 – 150	49.50	56.45	60.41	64.37	68.33	72.29	74.74	77.14	79.50	81.82
8 – 100	49.50	56.45	60.41	64.37	68.33	72.29	74.74	77.14	79.50	81.82

h=	150 mm	150 mm	150 mm	150 mm	150 mm	150 mm	150 mm	150 mm	150 mm	150 mm
10 - 250	49.50	59.40	65.27	65.27	65.27	65.27	65.27	65.27	65.27	65.27
10 – 200	49.50	59.40	66.95	70.91	74.87	78.83	81.28	81.59	81.59	81.59
10 – 150	49.50	59.40	66.95	70.91	74.87	78.83	81.28	83.68	86.04	88.36
10 – 100	53.96	60.93	66.95	70.91	74.87	78.83	81.28	83.68	86.04	88.36

h=	170 mm	170 mm	170 mm	170 mm	170 mm	170 mm	170 mm	170 mm	170 mm	170 mm
12 - 250	Production technically not possible	59.40	66.95	70.91	74.87	81.28	81.59	83.68	86.04	88.36
12 – 200		59.40	66.95	70.91	74.87	81.28	81.59	83.68	86.04	88.36
12 – 150		60.11	66.95	70.91	74.87	81.28	81.59	83.68	86.04	88.36
12 – 100		66.75	69.73	72.57	75.30	81.28	81.59	83.68	86.04	88.36

The verification of the pull-out lengths in construction section 2 must be carried out by the user!  
The tensile force cover must be verified by the user in the pull-out area of the reverse bend connection!  
According to DIN EN 1992-1-1, section 9.3.1.2, paragraph (1), at least half of the field reinforcement of solid slabs must be guided to the support and anchored there!

[www.nevoga.de](http://www.nevoga.de)

NEVOGA GmbH – Znaimer Str. 4 – D-83395 Freilassing – Telephone: 0049/8654/47310 – Fax: 0049/8654/4731 – 18



Prüfamt für Standsicherheit  
**LGA**  
Zweigstelle Landshut  
S-LA of

## Non-certified translation from the German original.

Page 71

Load tables Nevoga Plexus reinforcement connections

Absorbable shearing force transverse to the concrete joint (case c) without transverse force reinforcement

$$\text{Equation 6.8 } V_{Rd,s} = A_{sw} / S * z * f_{ywd} * \cot\Theta$$

$$\text{Equation 6.9 } V_{Rd,max} = 0.3 * b_w * z * v_1 * f_{cd} / \cot\Theta + \tan\Theta$$

$$V_{Rd,c} = \min(6.8;6.9)$$

$$\text{With } V_1 = 0.75 * (1.1 - f_{ck}/500) \leq 0.75$$

$$f_{ck} = 25 \text{ MN/m}^2$$

$$f_{yk} = 500 \text{ MN/m}^2$$

$$\gamma_c = 1.5$$

$$f_{ck,0.05} = 1.80 \text{ MN/m}^2$$

Assumptions: Data sheet Reverse bending Case c

$$\sigma_{cp} = 0 \quad b_w = 1.0 \text{ m}$$

Concrete quality C25/30

**Non-certified translation from the German original.**

Fritsche Ingenieure  
Ingenieurbüro für Bauwesen

Calculation  $V_{Rd,max}$  [kN/m]

d=	140 mm	160 mm	180 mm	200 mm	220 mm	240 mm	260 mm	280 mm
z=	75	95	115	135	155	175	195	215

h=	150 mm	150 mm	150 mm	150 mm	150 mm	150 mm	150 mm	150 mm
∅ – Partition [mm]								
8 - 250	117.57	148.92	180.28	211.63	242.98	274.33	305.69	337.04
8 - 200	117.57	148.92	180.28	211.63	242.98	274.33	305.69	337.04
8 - 150	117.57	148.92	180.28	211.63	242.98	274.33	305.69	337.04
8 - 100	117.57	148.92	180.28	211.63	242.98	274.33	305.69	337.04

h=	150 mm	150 mm	150 mm	150 mm	150 mm	150 mm	150 mm	150 mm
10 - 250	117.57	148.92	180.28	211.63	242.98	274.33	305.69	337.04
10 - 200	117.57	148.92	180.28	211.63	242.98	274.33	305.69	337.04
10 - 150	117.57	148.92	180.28	211.63	242.98	274.33	305.69	337.04
10 - 100	117.57	148.92	180.28	211.63	242.98	274.33	305.69	337.04

h=	170 mm	170 mm	170 mm	170 mm	170 mm	170 mm	170 mm	170 mm
12 - 250	117.57	148.92	180.28	211.63	242.98	274.33	305.69	337.04
12 - 200	117.57	148.92	180.28	211.63	242.98	274.33	305.69	337.04
12 - 150	117.57	148.92	180.28	211.63	242.98	274.33	305.69	337.04
12 - 100	117.57	148.92	180.28	211.63	242.98	274.33	305.69	337.04

[www.nevoga.de](http://www.nevoga.de)  
NEVOGA GmbH – Znaimer Str. 4 – D-83395 Freilassing – Telephone: 0049/8654/47310 – Fax: 0049/8654/4731 - 18

Prüfamt für Standsicherheit  
**LGA**  
Zweigstelle Landshut  
S-LA of

**Non-certified translation from the German original.**

Fritsche Ingenieure  
Ingenieurbüro für Bauwesen

Calculation rec.  $L_b$  [mm]

d=	140 mm	160 mm	180 mm	200 mm	220 mm	240 mm	260 mm	280 mm
----	--------	--------	--------	--------	--------	--------	--------	--------

h=	150 mm	150 mm	150 mm	150 mm	150 mm	150 mm	150 mm	150 mm
----	--------	--------	--------	--------	--------	--------	--------	--------

Ø – Partition [mm]								
8 - 250	182	231	280	328	377	426	474	523
8 – 200	146	185	224	263	302	340	379	418
8 – 150	109	139	168	197	226	255	285	314
8 – 100	80	92	112	131	151	170	190	209

h=	150 mm	150 mm	150 mm	150 mm	150 mm	150 mm	150 mm	150 mm
10 - 250	146	185	224	263	302	340	379	418
10 – 200	117	148	179	210	241	272	303	335
10 – 150	100	111	134	158	181	204	2128	251
10 – 100	100	100	100	105	121	136	152	167

h=	170 mm	170 mm	170 mm	170 mm	170 mm	170 mm	170 mm	170 mm
12 - 250	122	154	186	219	251	284	316	349
12 – 200	120	123	149	175	201	227	253	279
12 – 150	120	120	120	131	151	170	190	209
12 – 100	120	120	120	120	120	120	126	139

[www.nevoga.de](http://www.nevoga.de)  
NEVOGA GmbH – Znaimer Str. 4 – D-83395 Freilassing – Telephone: 0049/8654/47310 – Fax: 0049/8654/4731 - 18

Prüfamt für Standsicherheit  
**LGA**  
Zweigstelle Landshut  
S-LA of

# Non-certified translation from the German original.

Fritsche Ingenieure  
Ingenieurbüro für Bauwesen

Page 74

Result  $V_{Rd}$  [kN/m] Concrete quality C25/30 with transverse force reinforcement Transverse force vertical - Case c Data sheet  
Reverse bending according to EC, Figure 8  
Nevoga Plexus Type B

d=	140 mm	160 mm	180 mm	200 mm	220 mm	240 mm	260 mm	280 mm
----	--------	--------	--------	--------	--------	--------	--------	--------

h=	150 mm	150 mm	150 mm	150 mm	150 mm	150 mm	150 mm	150 mm
----	--------	--------	--------	--------	--------	--------	--------	--------

Ø – Partition [mm]								
8 - 250	96.70	96.70	96.70	96.70	96.70	96.70	96.70	96.70
8 - 200	117.57	120.87	120.87	120.87	120.87	120.87	120.87	120.87
8 - 150	117.57	148.92	161.96	161.16	161.16	161.16	161.16	161.16
8 - 100	117.57	148.92	180.28	211.63	241.74	241.74	241.74	241.74

h=	150 mm	150 mm	150 mm	150 mm	150 mm	150 mm	150 mm	150 mm
10 - 250	117.57	120.87	120.87	120.87	120.87	120.87	120.87	120.87
10 - 200	117.57	148.92	151.09	151.09	151.09	151.09	151.09	151.09
10 - 150	117.57	148.92	201.45	201.45	201.45	201.45	201.45	201.45
10 - 100	117.57	148.92	180.28	211.63	242.98	247.33	302.18	302.18

h=	170 mm	170 mm	170 mm	170 mm	170 mm	170 mm	170 mm	170 mm
12 - 250	117.57	148.92	164.38	164.38	164.38	164.38	164.38	164.38
12 - 200	117.57	148.92	180.28	205.48	205.48	205.48	205.48	205.48
12 - 150	117.57	148.92	180.28	211.63	242.98	273.97	273.97	273.97
12 - 100	117.57	148.92	180.28	211.63	242.98	274.33	305.69	337.04

The required transverse force reinforcement for vertical stirrups shall be calculated assuming  $\cot 8 = 1$  according to the following equation:  $\text{erf. } a_{sw} = V_{ed} / (f_{ywd} * z)$

The verification of the pull-out lengths in construction section 2 must be carried out by the user!

The tensile force cover must be verified by the user in the pull-out area of the reverse bend connection!

According to DIN EN 1992-1-1, section 9.3.1.2, paragraph (1), at least half of the field reinforcement of solid slabs must be guided to the support and anchored there!

According to DIN EN 1992-1-1, section 9.3.2 (1), the minimum thicknesses of the solid slabs for the arrangement of a transverse force reinforcement must be observed!

[www.nevoga.de](http://www.nevoga.de)  
NEVOGA GmbH – Znaimer Str. 4 – D-83395 Freilassing – Telephone: 0049/8654/47310 – Fax: 0049/8654/4731 – 18

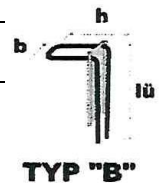

Prüfamt für  
Standicherheit  
LGA  
Zweigstelle Landshut  
S-LA of



## Non-certified translation from the German original.

Page 75

Load tables Nevoga Plexus reinforcement connections

Absorbable shearing force transverse to the concrete joint (case c) without transverse force reinforcement

$$\text{Formula 6.2a } V_{Rd,c} = c/0.5 * (C_{Rd,c} * k * (100 * \rho * f_{ck})^{1/3} = 0.12 * \sigma_{cp}) * b_x * d$$

$$\text{Equation 6.2b } V_{Rd,c} = c/0.5 * (v_{min} + 0.12 * \sigma_{cp}) * b_w * d$$

$$V_{Rd,c} = \max(6.2a; 6.2b)$$

$$\text{With } C_{Rd,c} = 0.15 / \gamma_c$$

$$= 0.1$$

$$f_{ck, 0.05} = 30 \text{ MN/m}^2$$

$$v_{min} = (0.0525 / \gamma_c) * k^{3/2} * f_{ck}^{1/2} \text{ for } d \leq 600 \text{ mm}$$

$$\text{Bracket support share } V_{Rd,ct,k} = t / \tan 35^\circ * t_{Rd}$$

$$V_{Rd,ct,k} = 36.92 \text{ kN/m } \varnothing 8 \text{ mm (manufacturer specification)}$$

$$V_{Rd,ct,k} = 44.30 \text{ kN/m } \varnothing 8 \text{ mm; } \varnothing 12 \text{ mm (manufacturer specification)}$$

$$\text{With } t = 30 \text{ mm } \varnothing 8 \text{ mm (manufacturer specification)}$$

$$t = 36 \text{ mm } \varnothing 10 \text{ mm; } \varnothing 12 \text{ mm (manufacturer specification)}$$

$$\alpha_{ct} = 0.85$$

$$\gamma_c = 1.5$$

$$f_{ctk} = 2.03 \text{ MN/m}^2$$

$$\text{Shearing angle} = 35^\circ \text{ bzw. } 0.61 \text{ RAD}$$

$$\text{Tan} = 0.70$$

$$T_{rd} = 0.86 \text{ MN/m}^2$$

Assumptions: Data sheet Reverse bending Case d

$$\sigma_{cp} = 0 \quad b_w = 1.0 \text{ m}$$

Concrete quality C30/37

Calculation of reinforcement degree  $P_1$  [ $10^{-3}$ ]

d=	100 mm	120 mm	140 mm	160 mm	180 mm	200 mm	220 mm	240 mm	260 mm	280 mm
k=	2	2	2	2	2	2	1.95	1.91	1.88	1.85
h=	150 mm	150 mm	150 mm	150 mm	150 mm	150 mm	150 mm	150 mm	150 mm	150 mm

Ø – Partition [mm]										
8 - 250	0.00201	0.00168	0.00144	0.00126	0.00112	0.00101	0.00091	0.00084	0.00077	0.00072
8 – 200	0.00251	0.00209	0.0018	0.00157	0.0014	0.00126	0.00114	0.00105	0.00097	0.0009
8 – 150	0.00335	0.00279	0.00239	0.00209	0.00186	0.00168	0.00152	0.0014	0.00129	0.0012
8 – 100	0.00503	0.00419	0.00359	0.00314	0.00279	0.00251	0.00228	0.00209	0.00193	0.0018

10 - 250	0.00314	0.00262	0.00224	0.00196	0.00175	0.00157	0.00143	0.00131	0.00121	0.00112
10 – 200	0.00393	0.00327	0.0028	0.00245	0.00218	0.00196	0.00178	0.00164	0.00151	0.0014
10 – 150	0.00524	0.00436	0.00374	0.00327	0.00291	0.00262	0.00238	0.00218	0.00201	0.00187
10 – 100	0.00785	0.00654	0.00561	0.00491	0.00436	0.00393	0.00357	0.00327	0.00302	0.0028

12 - 250	0.00452	0.00377	0.00323	0.00283	0.00251	0.00226	0.00206	0.00188	0.00174	0.00162
12 – 200	0.00565	0.00471	0.00404	0.00353	0.00314	0.00283	0.00257	0.00236	0.00217	0.00202
12 – 150	0.00754	0.00628	0.00539	0.00471	0.00419	0.00377	0.00343	0.00314	0.0029	0.00269
12 – 100	0.01131	0.00942	0.00808	0.00707	0.00628	0.00565	0.00514	0.00471	0.00435	0.00404

[www.nevoga.de](http://www.nevoga.de)  
NEVOGA GmbH – Znaimer Str. 4 – D-83395 Freilassing – Telephone: 0049/8654/47310 – Fax: 0049/8654/4731 - 18

Prüfamt für Standsicherheit  
**LGA**  
Zweigstelle Landshut  
S-LA \_\_\_\_\_ of \_\_\_\_\_

Calculation  $V_{Rd,c}$  [without console contact ratio] [kN/m]

d=	100 mm	120 mm	140 mm	160 mm	180 mm	200 mm	220 mm	240 mm	260 mm	280 mm
k=	2	2	2	2	2	2	1.95	1.91	1.88	1.85
$V_{Rd,c,min}$	21.69 kN/m	26.03 kN/m	30.36 kN/m	34.70 kN/m	39.04 kN/m	43.38 kN/m	46.04 kN/m	48.69 kN/m	51.27 kN/m	53.81 kN/m

h=	150 mm	150 mm	150 mm	150 mm	150 mm	150 mm	150 mm	150 mm	150 mm	150 mm
∅ – Partition [mm]										
8 - 250	21.69	26.03	30.36	34.70	39.04	43.38	46.06	48.69	51.27	53.81
8 – 200	21.69	26.03	30.36	34.70	39.04	43.38	46.06	48.69	51.27	53.81
8 – 150	21.69	26.03	30.36	34.70	39.04	43.38	46.06	48.69	51.27	53.81
8 – 100	21.69	26.03	30.36	34.70	39.04	43.38	46.06	48.69	51.27	53.81

h=	150 mm	150 mm	150 mm	150 mm	150 mm	150 mm	150 mm	150 mm	150 mm	150 mm
10 - 250	21.69	26.03	30.36	34.70	39.04	43.38	46.06	48.69	51.27	53.81
10 – 200	21.69	26.03	30.36	34.70	39.04	43.38	46.06	48.69	51.27	53.81
10 – 150	21.69	26.03	30.36	34.70	39.04	43.38	46.06	48.69	51.27	53.81
10 – 100	21.69	26.03	30.36	34.70	39.04	43.38	46.06	48.69	51.27	53.81

h=	170 mm	170 mm	170 mm	170 mm	170 mm	170 mm	170 mm	170 mm	170 mm	170 mm
12 - 250	21.69	26.03	30.36	34.70	39.04	43.38	46.06	48.69	51.27	53.81
12 – 200	21.69	26.03	30.36	34.70	39.04	43.38	46.06	48.69	51.27	53.81
12 – 150	21.69	26.03	30.36	34.70	39.04	43.38	46.06	48.69	51.27	53.81
12 – 100	25.90	29.25	32.41	35.43	39.04	43.38	46.06	48.69	51.27	53.81

[www.nevoga.de](http://www.nevoga.de)  
NEVOGA GmbH – Znaimer Str. 4 – D-83395 Freilassing – Telephone: 0049/8654/47310 – Fax: 0049/8654/4731 - 18

Prüfamt für Standsicherheit  
**LGA**  
Zweigstelle Landshut  
S-LA of

Calculation  $V_{Rd,c}$  [with console contact ratio] [kN/m]

d=	100 mm	120 mm	140 mm	160 mm	180 mm	200 mm	220 mm	240 mm	260 mm	280 mm
k=	2	2	2	2	2	2	1.95	1.91	1.88	1.85

h=	150 mm	150 mm	150 mm	150 mm	150 mm	150 mm	150 mm	150 mm	150 mm	150 mm
∅ – Partition [mm]										
8 - 250	58.51	62.95	67.28	71.62	75.96	80.30	82.92	85.61	88.19	90.73
8 - 200	58.51	62.95	67.28	71.62	75.96	80.30	82.92	85.61	88.19	90.73
8 - 150	58.51	62.95	67.28	71.62	75.96	80.30	82.92	85.61	88.19	90.73
8 - 100	58.51	62.95	67.28	71.62	75.96	80.30	82.92	85.61	88.19	90.73

h=	150 mm	150 mm	150 mm	150 mm	150 mm	150 mm	150 mm	150 mm	150 mm	150 mm
10 - 250	65.99	70.33	74.67	79.00	83.34	87.68	90.36	92.99	95.57	98.12
10 - 200	65.99	70.33	74.67	79.00	83.34	87.68	90.36	92.99	95.57	98.12
10 - 150	65.99	70.33	74.67	79.00	83.34	87.68	90.36	92.99	95.57	98.12
10 - 100	65.99	70.33	74.67	79.00	83.34	87.68	90.36	92.99	95.57	98.12

h=	170 mm	170 mm	170 mm	170 mm	170 mm	170 mm	170 mm	170 mm	170 mm	170 mm
12 - 250	65.99	70.33	74.67	79.00	83.34	87.68	90.36	92.99	95.57	98.12
12 - 200	65.99	70.33	74.67	79.00	83.34	87.68	90.36	92.99	95.57	98.12
12 - 150	65.99	70.33	74.67	79.00	83.34	87.68	90.36	92.99	95.57	98.12
12 - 100	65.99	70.33	74.67	79.00	83.34	87.68	90.36	92.99	95.57	98.12

[www.nevoga.de](http://www.nevoga.de)  
NEVOGA GmbH – Znaimer Str. 4 – D-83395 Freilassing – Telephone: 0049/8654/47310 – Fax: 0049/8654/4731 - 18

Prüfamt für Standsicherheit  
**LGA**  
Zweigstelle Landshut  
S-LA of

Calculation  $V_{Rd,max}$  [Adjustment of upper limit value] [kN/m]

d=	100 mm	120 mm	140 mm	160 mm	180 mm	200 mm	220 mm	240 mm	260 mm	280 mm
k=	2	2	2	2	2	2	1,95	1,91	1,88	1,85
	54,22 kN/m	65,07 kN/m	75,91 kN/m	86,75 kN/m	97,60 kN/m	103,44 kN/m	121,72 kN/m	128,18 kN/m	128,18 kN/m	134,54 kN/m

h=	150 mm	150 mm	150 mm	150 mm	150 mm	150 mm	150 mm	150 mm	150 mm	150 mm
Ø – Partition [mm]										
8 - 250	54.22	65.07	75.91	86.75	97.60	108.44	115.15	121.72	128.18	134.54
8 - 200	54.22	65.07	75.91	86.75	97.60	108.44	115.15	121.72	128.18	134.54
8 - 150	54.22	65.07	75.91	86.75	97.60	108.44	115.15	121.72	128.18	134.54
8 - 100	54.22	65.07	75.91	86.75	97.60	108.44	115.15	121.72	128.18	134.54

h=	150 mm	150 mm	150 mm	150 mm	150 mm	150 mm	150 mm	150 mm	150 mm	150 mm
10 - 250	54.22	65.07	75.91	86.75	97.60	108.44	115.15	121.72	128.18	134.54
10 - 200	54.22	65.07	75.91	86.75	97.60	108.44	115.15	121.72	128.18	134.54
10 - 150	54.22	65.07	75.91	86.75	97.60	108.44	115.15	121.72	128.18	134.54
10 - 100	54.22	65.07	75.91	86.75	97.60	108.44	115.15	121.72	128.18	134.54

h=	170 mm	170 mm	170 mm	170 mm	170 mm	170 mm	170 mm	170 mm	170 mm	170 mm
12 - 250	54.22	65.07	75.91	86.75	97.60	108.44	115.15	121.72	128.18	134.54
12 - 200	54.22	65.07	75.91	86.75	97.60	108.44	115.15	121.72	128.18	134.54
12 - 150	56.56	65.07	75.91	86.75	97.60	108.44	115.15	121.72	128.18	134.54
12 - 100	64.75	73.12	81.03	88.57	97.60	108.44	115.15	121.72	128.18	134.54

[www.nevoga.de](http://www.nevoga.de)  
NEVOGA GmbH – Znaimer Str. 4 – D-83395 Freilassing – Telephone: 0049/8654/47310 – Fax: 0049/8654/4731 - 18

Prüfamt für Standsicherheit  
**LGA**  
Zweigstelle Landshut  
S-LA of

Calculation  $V_{Rd,c}$  [Adjustment of upper limit value] [kN/m]

d=	100 mm	120 mm	140 mm	160 mm	180 mm	200 mm	220 mm	240 mm	260 mm	280 mm
----	--------	--------	--------	--------	--------	--------	--------	--------	--------	--------

h=	150 mm	150 mm	150 mm	150 mm	150 mm	150 mm	150 mm	150 mm	150 mm	150 mm
----	--------	--------	--------	--------	--------	--------	--------	--------	--------	--------

Ø – Partition [mm]										
8 - 250	54.22	62.95	67.28	71.62	75.96	80.30	82.98	85.61	88.19	90.73
8 - 200	54.22	62.95	67.28	71.62	75.96	80.30	82.98	85.61	88.19	90.73
8 - 150	54.22	62.95	67.28	71.62	75.96	80.30	82.98	85.61	88.19	90.73
8 - 100	54.22	62.95	67.28	71.62	75.96	80.30	82.98	85.61	88.19	90.73

h=	150 mm	150 mm	150 mm	150 mm	150 mm	150 mm	150 mm	150 mm	150 mm	150 mm
10 - 250	54.22	65.07	74.67	79.00	83.34	87.68	90.36	92.99	95.57	98.12
10 - 200	54.22	65.07	74.67	79.00	83.34	87.68	90.36	92.99	95.57	98.12
10 - 150	54.22	65.07	74.67	79.00	83.34	87.68	90.36	92.99	95.57	98.12
10 - 100	54.22	65.07	74.67	79.00	83.34	87.68	90.36	92.99	95.57	98.12

h=	170 mm	170 mm	170 mm	170 mm	170 mm	170 mm	170 mm	170 mm	170 mm	170 mm
12 - 250	54.22	65.07	74.67	79.00	83.34	87.68	90.36	92.99	95.57	98.12
12 - 200	54.22	65.07	74.67	79.00	83.34	87.68	90.36	92.99	95.57	98.12
12 - 150	56.56	65.07	74.67	79.00	83.34	87.68	90.36	92.99	95.57	98.12
12 - 100	64.75	73.12	76.71	79.73	83.34	87.68	90.36	92.99	95.57	98.12

[www.nevoga.de](http://www.nevoga.de)  
NEVOGA GmbH – Znaimer Str. 4 – D-83395 Freilassing – Telephone: 0049/8654/47310 – Fax: 0049/8654/4731 - 18

Prüfamt für Standsicherheit  
**LGA**  
Zweigstelle Landshut  
S-LA of

Calculation rec.  $L_b$  [mm]

d=	100 mm	120 mm	140 mm	160 mm	180 mm	200 mm	220 mm	240 mm	260 mm	280 mm
----	--------	--------	--------	--------	--------	--------	--------	--------	--------	--------

h=	150 mm	150 mm	150 mm	150 mm	150 mm	150 mm	150 mm	150 mm	150 mm	150 mm
----	--------	--------	--------	--------	--------	--------	--------	--------	--------	--------

Ø – Partition [mm]										
8 - 250	138	150	171	182	193	204	211	218	224	231
8 - 200	110	128	137	146	155	163	169	174	179	185
8 - 150	83	96	103	109	116	123	127	131	135	138
8 - 100	80	80	80	80	80	82	84	87	90	92

h=	150 mm	150 mm	150 mm	150 mm	150 mm	150 mm	150 mm	150 mm	150 mm	150 mm
10 - 250	110	132	152	161	170	178	184	189	195	200
10 - 200	100	106	122	129	136	143	147	151	156	160
10 - 150	100	100	100	100	102	107	110	114	117	120
10 - 100	100	100	100	100	100	100	100	100	100	100

h=	170 mm	170 mm	170 mm	170 mm	170 mm	170 mm	170 mm	170 mm	170 mm	170 mm
12 - 250	120	120	127	134	141	149	153	158	162	166
12 - 200	120	120	120	120	120	120	123	126	130	133
12 - 150	120	120	120	120	120	120	120	120	120	120
12 - 100	120	120	120	120	120	120	120	120	120	120

[www.nevoga.de](http://www.nevoga.de)  
NEVOGA GmbH – Znaimer Str. 4 – D-83395 Freilassing – Telephone: 0049/8654/47310 – Fax: 0049/8654/4731 - 18

Prüfamt für Standsicherheit  
**LGA**  
Zweigstelle Landshut  
S-LA of

**Non-certified translation from the German original.**

Result  $V_{Rd}$  [kN/m] Concrete quality C30/37 Transverse force vertical - Case c Data sheet Reverse bending acc. to EC, Figure 8  
The requirements for consideration of the bracket support component in accordance with DBV data sheet Section 5.3 (6) shall be met.

Nevoga Plexus Type B

d=	100 mm	120 mm	140 mm	160 mm	180 mm	200 mm	220 mm	240 mm	260 mm	280 mm
----	--------	--------	--------	--------	--------	--------	--------	--------	--------	--------

h=	150 mm	150 mm	150 mm	150 mm	150 mm	150 mm	150 mm	150 mm	150 mm	150 mm
----	--------	--------	--------	--------	--------	--------	--------	--------	--------	--------

Ø – Partition [mm]										
8 - 250	54.22	58.96	58.96	58.96	58.96	58.96	58.96	58.96	58.96	58.96
8 – 200	54.22	62.95	67.28	71.62	73.71	73.71	73.71	73.71	73.71	73.71
8 – 150	54.22	62.95	67.28	71.62	75.96	80.30	82.98	85.61	88.19	90.73
8 – 100	54.22	62.95	67.28	71.62	75.96	80.30	82.98	85.61	88.19	90.73

h=	150 mm	150 mm	150 mm	150 mm	150 mm	150 mm	150 mm	150 mm	150 mm	150 mm
10 - 250	54.22	65.07	73.71	73.71	73.71	73.71	73.71	73.71	73.71	73.71
10 – 200	54.22	65.07	74.67	79.00	83.84	87.68	90.36	92.13	92.13	92.13
10 – 150	54.22	65.07	74.67	79.00	83.84	87.68	90.36	92.99	95.57	98.12
10 – 100	57.34	65.07	74.67	79.00	83.84	87.68	90.36	92.99	95.57	98.12

h=	170 mm	170 mm	170 mm	170 mm	170 mm	170 mm	170 mm	170 mm	170 mm	170 mm
12 - 250	Production technically not possible	65.07	74.67	79.00	83.84	87.68	90.36	92.99	95.57	98.12
12 – 200		65.07	74.67	79.00	83.84	87.68	90.36	92.99	95.57	98.12
12 – 150		65.07	74.67	79.00	83.84	87.68	90.36	92.99	95.57	98.12
12 – 100		73.12	76.71	79.73	83.84	87.68	90.36	92.99	95.57	98.12

The verification of the pull-out lengths in construction section 2 must be carried out by the user!

The tensile force cover must be verified by the user in the pull-out area of the reverse bend connection!

According to DIN EN 1992-1-1, section 9.3.1.2, paragraph (1), at least half of the field reinforcement of solid slabs must be guided to the support and anchored there!

[www.nevoga.de](http://www.nevoga.de)  
NEVOGA GmbH – Znaimer Str. 4 – D-83395 Freilassing – Telephone: 0049/8654/47310 – Fax: 0049/8654/4731 - 18



Prüfamt für Standsicherheit  
**LGA**  
Zweigstelle Landshut  
S-LA of



Load tables Nevoga Plexus reinforcement connections

Absorbable shearing force transverse to the concrete joint (case c) with transverse force reinforcement

$$\begin{aligned} \text{Equation 6.8} \quad V_{Rd,s} &= A_{sw} / S) * z * f_{ywd} * \cot\Theta \\ \text{Equation 6.9} \quad V_{Rd,max} &= 0.3 * b_w * z * v_1 * f_{cd} / \cot\Theta + \tan\Theta \end{aligned}$$

$$\begin{aligned} V_{Rd,c} &= \min(6.8;6.9) \\ \text{With} \quad V_1 &= 0.75 * (1.1 - f_{ck}/500) \leq \\ &= 0.75 \end{aligned}$$

$$f_{ck} = 30 \quad \text{MN/m}^2$$

$$f_{yk} = 500 \quad \text{MN/m}^2$$

$$y_c = 1.5$$

$$f_{ck,0.05} = 2.03 \text{ MN/m}^2$$

Assumptions: Data sheet Reverse bending Case c

$$\sigma_{cp} = 0 \quad b_w = 1.0 \text{ m}$$

Concrete quality C30/37

[www.nevoga.de](http://www.nevoga.de)  
NEVOGA GmbH – Znaimer Str. 4 – D-83395 Freilassing – Telephone: 0049/8654/47310 – Fax: 0049/8654/4731 - 18

Prüfamt für Standsicherheit  
**LGA**  
Zweigstelle Landshut  
S-LA of

**Non-certified translation from the German original.**

Fritsche Ingenieure  
Ingenieurbüro für Bauwesen

Page 84

Calculation  $V_{Rd,max}$  [kN/m]

d=	140 mm	160 mm	180 mm	200 mm	220 mm	240 mm	260 mm	280 mm
z=	75	95	115	135	155	175	195	215

h=	150 mm	150 mm	150 mm	150 mm	150 mm	150 mm	150 mm	150 mm
∅ – Partition [mm]								
8 - 250	141.09	178.71	216.33	253.95	291.58	329.20	366.82	404.45
8 - 200	141.09	178.71	216.33	253.95	291.58	329.20	366.82	404.45
8 - 150	141.09	178.71	216.33	253.95	291.58	329.20	366.82	404.45
8 - 100	141.09	178.71	216.33	253.95	291.58	329.20	366.82	404.45

h=	150 mm	150 mm	150 mm	150 mm	150 mm	150 mm	150 mm	150 mm
10 - 250	141.09	178.71	216.33	253.95	291.58	329.20	366.82	404.45
10 - 200	141.09	178.71	216.33	253.95	291.58	329.20	366.82	404.45
10 - 150	141.09	178.71	216.33	253.95	291.58	329.20	366.82	404.45
10 - 100	141.09	178.71	216.33	253.95	291.58	329.20	366.82	404.45

h=	170 mm	170 mm	170 mm	170 mm	170 mm	170 mm	170 mm	170 mm
12 - 250	141.09	178.71	216.33	253.95	291.58	329.20	366.82	404.45
12 - 200	141.09	178.71	216.33	253.95	291.58	329.20	366.82	404.45
12 - 150	141.09	178.71	216.33	253.95	291.58	329.20	366.82	404.45
12 - 100	141.09	178.71	216.33	253.95	291.58	329.20	366.82	404.45

[www.nevoga.de](http://www.nevoga.de)  
NEVOGA GmbH – Znaimer Str. 4 – D-83395 Freilassing – Telephone: 0049/8654/47310 – Fax: 0049/8654/4731 - 18

Prüfamt für Standsicherheit  
**LGA**  
Zweigstelle Landshut  
S-LA of

**Non-certified translation from the German original.**

Calculation rec.  $L_b$  [mm]

d=	140 mm	160 mm	180 mm	200 mm	220 mm	240 mm	260 mm	280 mm
----	--------	--------	--------	--------	--------	--------	--------	--------

h=	150 mm	150 mm	150 mm	150 mm	150 mm	150 mm	150 mm	150 mm
----	--------	--------	--------	--------	--------	--------	--------	--------

Ø – Partition [mm]								
8 - 250	194	245	297	349	401	452	504	556
8 - 200	155	196	238	279	320	362	403	444
8 - 150	116	147	178	209	240	271	302	333
8 - 100	80	98	119	140	160	181	202	222

h=	150 mm	150 mm	150 mm	150 mm	150 mm	150 mm	150 mm	150 mm
10 - 250	155	196	238	279	320	362	403	444
10 - 200	124	157	190	223	256	289	322	356
10 - 150	100	118	143	167	192	217	242	267
10 - 100	100	100	100	112	128	145	161	178

h=	170 mm	170 mm	170 mm	170 mm	170 mm	170 mm	170 mm	170 mm
12 - 250	129	164	198	233	267	301	336	370
12 - 200	120	131	158	186	214	241	269	296
12 - 150	120	120	120	140	160	181	202	222
12 - 100	120	120	120	120	120	121	134	148

[www.nevoga.de](http://www.nevoga.de)  
NEVOGA GmbH – Znaimer Str. 4 – D-83395 Freilassing – Telephone: 0049/8654/47310 – Fax: 0049/8654/4731 - 18

Prüfamt für Standsicherheit  
**LGA**  
Zweigstelle Landshut  
S-LA of

**Non-certified translation from the German original.**

Result  $V_{rd}$  [kN/m] Concrete quality C30/37 with transverse force reinforcement Transverse force vertical - Case c Data sheet  
Reverse bending according to EC, Figure 8  
Nevoga Plexus Type B

d=	140 mm	160 mm	180 mm	200 mm	220 mm	240 mm	260 mm	280 mm
----	--------	--------	--------	--------	--------	--------	--------	--------

h=	150 mm	150 mm	150 mm	150 mm	150 mm	150 mm	150 mm	150 mm
----	--------	--------	--------	--------	--------	--------	--------	--------

∅ – Partition [mm]								
8 - 250	109.19	109.19	109.19	109.19	109.19	109.19	109.19	109.19
8 - 200	136.49	136.49	136.49	136.49	136.49	136.49	136.49	136.49
8 - 150	141.09	178.71	181.99	181.99	181.99	181.99	181.99	181.99
8 - 100	141.09	178.71	216.33	235.95	272.99	272.99	272.99	272.99

h=	150 mm	150 mm	150 mm	150 mm	150 mm	150 mm	150 mm	150 mm
10 - 250	136.49	136.49	136.49	136.49	136.49	136.49	136.49	136.49
10 - 200	141.09	170.62	170.62	170.62	170.62	170.62	170.62	170.62
10 - 150	141.09	178.71	216.33	227.49	227.49	227.49	227.49	227.49
10 - 100	141.09	178.71	216.33	253.95	291.58	329.20	341.23	341.23

h=	170 mm	170 mm	170 mm	170 mm	170 mm	170 mm	170 mm	170 mm
12 - 250	141.09	178.71	185.63	185.63	185.63	185.63	185.63	185.63
12 - 200	141.09	178.71	216.33	232.04	232.04	232.04	232.04	232.04
12 - 150	141.09	178.71	216.33	235.95	291.58	309.38	309.38	309.38
12 - 100	141.09	178.71	216.33	235.95	291.58	329.20	366.82	404.45

The required transverse force reinforcement for vertical stirrups shall be calculated assuming  $\cot \theta = 1$  according to the following equation:  $\text{erf. } a_{sw} = V_{ed} / (f_{ywd} * z)$

The verification of the pull-out lengths in construction section 2 must be carried out by the user!

The tensile force cover must be verified by the user in the pull-out area of the reverse bend connection!

According to DIN EN 1992-1-1, section 9.3.1.2, paragraph (1), at least half of the field reinforcement of solid slabs must be guided to the support and anchored there!

According to DIN EN 1992-1-1, section 9.3.2 (1), the minimum thicknesses of the solid slabs for the arrangement of a transverse force reinforcement must be observed!

[www.nevoga.de](http://www.nevoga.de)

NEVOGA GmbH – Znaimer Str. 4 – D-83395 Freilassing – Telephone: 0049/8654/47310 – Fax: 0049/8654/4731 – 18



Prüfamt für  
Standicherheit  
LGA  
Zweigstelle Landshut  
S-LA of

Non-certified translation from the German original.

Author: Fritsche Ingenieurbüro für Bauwesen Program: Ingenieure	
Building structure : NEVOGA Plexus reinforcement connection	Date 08/2013
8. <u>Calculation of shearing force that can be absorbed Case d</u>      <div data-bbox="735 976 1042 1140" style="border: 1px solid black; padding: 5px; text-align: center;"><p>Prüfamt für Standsicherheit <b>LGA</b> Zweigstelle Landshut S-LA                      of</p></div>	
Component: Load capacity calculation EC 2 Block: according to DBV data sheet 01/2011 page: 87 ..... Process:	ARCHIVE NO.:

## Non-certified translation from the German original.

Page 88

Load tables Nevoga Plexus reinforcement connections

Absorbable shearing force transverse to the concrete joint (case d) without transverse force reinforcement

Formula 6.2a  $V_{Rd,c} = c/0.5 * (C_{Rd,c} * k * (100 * \pi * f_{ck})^{1/3} = 0.12 * \sigma_{cp}) * b_x * d$

Equation 6.2b  $V_{Rd,c} = c/0.5 * (v_{min} + 0.12 * \sigma_{cp}) * b_w * d$

$$V_{Rd,c} = \max(6.2a; 6.2b)$$

With  $C_{Rd,c} = 0.15 / \gamma_c$

$$= 0.1$$

$f_{ck} = 20 \text{ MN/m}^2$

$$v_{min} = (0.0525 / \gamma_c) * k^{3/2} * f_{ck}^{1/2} \text{ for } d \leq 600 \text{ mm}$$

$$\alpha_{ct} = 0.85$$

$$\gamma_c = 1.5$$

$$f_{ctk,0.05} = b_w = 1.55 \text{ m}$$

Assumptions: Data sheet Reverse bending Case d

$$\sigma_{cp} = 0 \quad b_w = 1.0 \text{ m}$$

Calculation of reinforcement degree  $P_1$  [10E-3]

Box width B =	85 mm	115 mm	145 mm	175 mm	205 mm	225 mm
d=	72.5 mm	102.5 mm	132.5 mm	162.5 mm	192.5 mm	212.5 mm
k=	2	2	2	2	2	1.97014

$\emptyset$ - Partition [mm]						
8 - 250	0.00227	0.00196	0.00152	0.00124	0.00104	0.00095
8 - 200	0.00347	0.00245	0.0019	0.00155	0.00131	0.00118
8 - 150	0.00462	0.00327	0.00253	0.00206	0.00174	0.00158
8 - 100	0.00693	0.0049	0.00379	0.00309	0.00261	0.00237

10 - 250	0.00433	0.00306	0.00237	0.00193	0.00163	0.00148
10 - 200	0.00542	0.00383	0.00296	0.00242	0.00204	0.00185
10 - 150	0.00722	0.00511	0.00395	0.00322	0.00272	0.00246
10 - 100	0.01083	0.00766	0.00593	0.00483	0.00408	0.0037

12 - 250	0.00624	0.00441	0.00341	0.00278	0.00235	0.00213
12 - 200	0.0078	0.00552	0.00427	0.00348	0.00294	0.00266
12 - 150	0.0104	0.00736	0.00569	0.00464	0.00392	0.00355
12 - 100	0.0156	0.01103	0.00854	0.00696	0.00588	0.00532

Prüfamt für Standsicherheit  
**LGA**  
 Zweigstelle Landshut  
 S-LA of

[www.nevoga.de](http://www.nevoga.de)

NEVOGA GmbH – Znaimer Str. 4 – D-83395 Freilassing – Telephone: 0049/8654/47310 – Fax: 0049/8654/4731 - 18

**Non-certified translation from the German original.**

Calculation  $V_{Rd,c}$  [kN/m]

Box width B =	85 mm	115 mm	145 mm	175 mm	205 mm	225 mm
d=	72.5 mm	102.5 mm	132.5 mm	162.5 mm	192.5 mm	212.5 mm
k =	2	2	2	2	2	1.97014
$V_{Rd,c,min}$	12.84 kN/m	18.15 kN/m	23.46 kN/m	28.78 kN/m	34.09 kN/m	36.79 kN/m

h=	350 mm	350 mm	350 mm	350 mm	350 mm	350 mm
----	--------	--------	--------	--------	--------	--------

∅ – Partition [mm]						
8 - 250	12.84	18.15	23.46	28.78	34.09	36.79
8 – 200	12.84	18.15	23.46	28.78	34.09	36.79
8 – 150	12.84	18.15	23.46	28.78	34.09	36.79
8 – 100	12.84	18.15	23.46	28.78	34.09	36.79

h=	430 mm	430 mm	430 mm	430 mm	430 mm	430 mm
10 - 250	12.84	18.15	23.46	28.78	34.09	36.79
10 – 200	12.84	18.15	23.46	28.78	34.09	36.79
10 – 150	14.13	18.15	23.46	28.78	34.09	36.79
10 – 100	16.17	20.37	24.17	28.78	34.09	36.79

h=	510 mm	510 mm	510 mm	510 mm	510 mm	510 mm
12 - 250	13.45	18.15	23.46	28.78	34.09	36.79
12 – 200	14.49	18.26	23.46	28.78	34.09	36.79
12 – 150	15.95	20.09	23.84	28.78	34.09	36.79
12 – 100	18.26	23.00	27.29	31.27	35.01	36.84

Calculation rec.  $L_b$  [mm]

d=	72.5 mm	102.5 mm	132.5 mm	162.5 mm	192.5 mm	212.5 mm
----	---------	----------	----------	----------	----------	----------

h=	350 mm	350 mm	350 mm	350 mm	350 mm	350 mm
----	--------	--------	--------	--------	--------	--------

∅ – Partition [mm]						
8 - 250	80	80	80	96	114	123
8 – 200	80	80	80	80	91	98
8 – 150	80	80	80	80	80	80
8 – 100	80	80	80	80	80	80

h=	430 mm	430 mm	430 mm	430 mm	430 mm	430 mm
10 - 250	100	100	100	100	100	100
10 – 200	100	100	100	100	100	100
10 – 150	100	100	100	100	100	100
10 – 100	100	100	100	100	100	100

h=	510 mm	510 mm	510 mm	510 mm	510 mm	510 mm
12 - 250	120	120	120	120	120	120
12 – 200	120	120	120	120	120	120
12 – 150	120	120	120	120	120	120
12 – 100	120	120	120	120	120	120

Prüfamt für Standsicherheit  
**LGA**  
Zweigstelle Landshut  
S-LA of

Result

$V_{Rd}$	[kN/m]	Concrete quality	C20/25
Transverse force vertical - Case d data sheet Reverse bending to EC, Fig. 8			
Data sheet reverse bending figure 8d			
Good bond conditions according to DIN EN 1992-1-1			
$\sigma_{cd}$	=	0	$b_w = 1.0$ m
Nevoga Plexus Type DD			

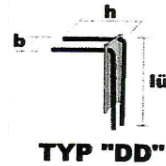

Box width B =	85 mm	115 mm	145 mm	175 mm	205 mm	225 mm
d=	72.5 mm	102.5 mm	132.5 mm	162.5 mm	192.5 mm	212.5 mm

h=	350 mm	350 mm	350 mm	350 mm	350 mm	350 mm	
Ø – Partition [mm]							
8 – 250	12.84	18.15	23.46	28.78	34.09	36.79	L <sub>s</sub> = 320 mm
8 – 200	12.84	18.15	23.46	28.78	34.09	36.79	
8 – 150	12.84	18.15	23.46	28.78	34.09	36.79	
8 – 100	13.93	18.15	23.46	28.78	34.09	36.79	

h=	430 mm	430 mm	430 mm	430 mm	430 mm	430 mm	L <sub>s</sub> = 390 mm
10 – 250	12.84	18.15	23.46	28.78	34.09	36.79	
10 – 200	12.84	18.15	23.46	28.78	34.09	36.79	
10 – 150	14.13	18.15	23.46	28.78	34.09	36.79	
10 – 100	16.17	20.37	24.17	28.78	34.09	36.79	

h=	510 mm	510 mm	510 mm	510 mm	510 mm	510 mm	L <sub>s</sub> = 460 mm
12 – 250	13.45	18.15	23.46	28.78	34.09	36.79	
12 – 200	14.49	18.26	23.46	28.78	34.09	36.79	
12 – 100	18.26	23.00	27.29	31.27	35.01	36.84	

The verification of the pull-out lengths in construction section 2 must be carried out by the user!  
The tensile force cover must be verified by the user in the pull-out area of the reverse bend connection!  
According to DIN EN 1992-1-1, section 9.3.1.2, paragraph (1), at least half of the field reinforcement of solid slabs must be guided to the support and anchored there!

[www.nevoga.de](http://www.nevoga.de)

NEVOGA GmbH – Znaimer Str. 4 – D-83395 Freilassing – Telephone: 0049/8654/47310 – Fax: 0049/8654/4731 - 18

Prüfamt für Standsicherheit  
**LGA**  
Zweigstelle Landshut

S-LA of



Load tables Nevoga Plexus reinforcement connections

Absorbable shearing force transverse to the concrete joint (case e) without transverse force reinforcement

Formula 6.2a  $V_{Rd,c} = c/0.5 * (C_{Rd,c} * k * (100 * \rho_i * f_{ck})^{1/3} = 0.12 * \sigma_{cp}) * b_x * d$

Equation 6.2b  $V_{Rd,c} = c/0.5 * (v_{min} + 0.12 * \sigma_{cp}) * b_w * d$

$V_{Rd,c} = \max(6.2a; 6.2b)$

With  $C_{Rd,c} = 0.15 / \gamma_c$

$= 0.1$

$f_{ck} = 25 \text{ MN/m}^2$

$v_{min} = (0.0525 / \gamma_c) * k^{3/2} * f_{ck}^{1/2}$  for  $d \leq 600 \text{ mm}$

$\alpha_{ct} = 0.85$

$\gamma_c = 1.5$

$f_{ctk,0.05} = 1.80 \text{ MN/m}^2$

Assumptions: Data sheet Reverse bending Case d

$\sigma_{cp} = 0 \quad b_w = 1.0 \text{ m}$

Calculation of reinforcement degree P1 [10E-3]

Box width B =	85 mm	115 mm	145 mm	175 mm	205 mm	225 mm
d=	72.5 mm	102.5 mm	132.5 mm	162.5 mm	192.5 mm	212.5 mm
k =	2	2	2	2	2	1.97014

$\emptyset$ – Partition [mm]						
8 – 250	0.00277	0.00196	0.00512	0.00124	0.00104	0.00095
8 – 200	0.00347	0.00245	0.0019	0.00155	0.00131	0.00118
8 – 150	0.00462	0.00327	0.00253	0.00206	0.00174	0.00158
8 – 100	0.00693	0.0049	0.00379	0.00309	0.00261	0.00237

10 – 250	0.00433	0.00306	0.00237	0.00193	0.00163	0.00148
10 – 200	0.00542	0.00383	0.00296	0.00242	0.00204	0.00185
10 – 150	0.00722	0.00511	0.00395	0.00322	0.00272	0.00246
10 – 100	0.001983	0.00766	0.00593	0.00483	0.00408	0.0037

12 – 250	0.00624	0.00441	0.00341	0.00278	0.00235	0.00213
12 – 200	0.0078	0.00552	0.00427	0.00348	0.00294	0.00266
12 – 150	0.0104	0.00736	0.00569	0.00464	0.00392	0.00355
12 – 100	0.0156	0.01103	0.00854	0.00696	0.00588	0.00532

Prüfamt für Standsicherheit  
**LGA**  
Zweigstelle Landshut  
S-LA of

**Non-certified translation from the German original.**

Calculation  $V_{Rd,c}$  [kN/m]

Box width B =	85 mm	115 mm	145 mm	175 mm	205 mm	225 mm
d=	72.5 mm	102.5 mm	132.5 mm	162.5 mm	192.5 mm	212.5 mm
k =	2	2	2	2	2	1.97014
$V_{Rd,c,min}$	14.35 kN/m	20.29 kN/m	26.23 kN/m	32.17 kN/m	38.11 kN/m	41.13 kN/m

h=	350 mm	350 mm	350 mm	350 mm	350 mm	350 mm
∅ – Partition [mm]						
8 - 250	14.35	20.29	26.23	32.17	38.11	41.13
8 – 200	14.35	20.29	26.23	32.17	38.11	41.13
8 – 150	14.35	20.29	26.23	32.17	38.11	41.13
8 – 100	15.01	20.29	26.23	32.17	38.11	41.13

h=	430 mm	430 mm	430 mm	430 mm	430 mm	430 mm
10 - 250	14.35	20.29	26.23	32.17	38.11	41.13
10 – 200	14.35	20.29	26.23	32.17	38.11	41.13
10 – 150	15.22	20.29	26.23	32.17	38.11	41.13
10 – 100	17.42	21.94	26.23	32.17	38.11	41.13

h=	510 mm	510 mm	510 mm	510 mm	510 mm	510 mm
12 - 250	14.49	20.29	26.23	32.17	38.11	41.13
12 – 200	15.61	20.29	26.23	32.17	38.11	41.13
12 – 150	17.18	21.64	26.23	32.17	38.11	41.13
12 – 100	19.67	24.78	29.40	33.69	38.11	41.13

Calculation rec.  $L_b$  [mm]

d=	72.5 mm	102.5 mm	132.5 mm	162.5 mm	192.5 mm	212.5 mm
----	---------	----------	----------	----------	----------	----------

h=	350 mm	350 mm	350 mm	350 mm	350 mm	350 mm
∅ – Partition [mm]						
8 - 250	80	80	80	92	109	118
8 – 200	80	80	80	80	88	95
8 – 150	80	80	80	80	80	80
8 – 100	80	80	80	80	80	80

h=	430 mm	430 mm	430 mm	430 mm	430 mm	430 mm
10 - 250	100	100	100	100	100	100
10 – 200	100	100	100	100	100	100
10 – 150	100	100	100	100	100	100
10 – 100	100	100	100	100	100	100

h=	510 mm	510 mm	510 mm	510 mm	510 mm	510 mm
12 - 250	120	120	120	120	120	120
12 – 200	120	120	120	120	120	120
12 – 150	120	120	120	120	120	120
12 – 100	120	120	120	120	120	120

Prüfamt für Standsicherheit  
**LGA**  
Zweigstelle Landshut  
S-LA of

# Non-certified translation from the German original.

Fritsche Ingenieure  
Ingenieurbüro für Bauwesen

Result

$V_{Rd}$	[kN/m]	Concrete quality	C25/30
Transverse force vertical - Case d data sheet Reverse bending to EC 2, Fig. 8			
Data sheet reverse bending figure 8d			
Good bond conditions according to DIN EN 1992-1-1			
$\sigma_{cd}$	=	0	$b_w = 1.0$ m
Nevoga Plexus Type DD			

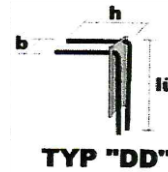

Box width B	85 mm	115 mm	145 mm	175 mm	205 mm	225 mm
=						
d=	72.5 mm	102.5 mm	132.5 mm	162.5 mm	192.5 mm	212.5 mm

h=	350 mm	350 mm	350 mm	350 mm	350 mm	350 mm	
Ø - Partition [mm]							
8 - 250	14.35	20.29	26.33	32.17	38.11	41.13	L <sub>s</sub> = 320 mm
8 - 200	14.35	20.29	26.33	32.17	38.11	41.13	
8 - 150	14.35	20.29	26.33	32.17	38.11	41.13	
8 - 100	15.01	20.29	26.33	32.17	38.11	41.13	

h=	430 mm	430 mm	430 mm	430 mm	430 mm	430 mm	L <sub>s</sub> = 390 mm
10 - 250	14.35	20.29	26.33	32.17	38.11	41.13	
10 - 200	14.35	20.29	26.33	32.17	38.11	41.13	
10 - 150	15.22	20.29	26.33	32.17	38.11	41.13	
10 - 100	17.42	21.94	26.33	32.17	38.11	41.13	

h=	510 mm	510 mm	510 mm	510 mm	510 mm	510 mm	L <sub>s</sub> = 460 mm
12 - 250	14.49	20.29	26.23	32.17	38.11	41.13	
12 - 200	15.61	20.29	26.23	32.17	38.11	41.13	
12 - 150	17.18	21.64	26.23	32.17	38.11	41.13	
12 - 100	19.67	24.78	29.40	33.69	38.11	41.13	

The verification of the pull-out lengths in construction section 2 must be carried out by the user!  
The tensile force cover must be verified by the user in the pull-out area of the reverse bend connection!  
According to DIN EN 1992-1-1, section 9.3.1.2, paragraph (1), at least half of the field reinforcement of solid slabs must be guided to the support and anchored there!

[www.nevoga.de](http://www.nevoga.de)  
NEVOGA GmbH – Znaimer Str. 4 – D-83395 Freilassing – Telephone: 0049/8654/47310 – Fax: 0049/8654/4731 - 18

Prüfamt für Standsicherheit  
**LGA**  
Zweigstelle Landshut  
S-LA of

## Non-certified translation from the German original.

Fritsche Ingenieure

Ingenieurbüro für Bauwesen

Load tables Nevoga Plexus reinforcement connections

Page 94

Absorbable shearing force transverse to the concrete joint (case d) without transverse force reinforcement

Formula 6.2a  $V_{Rd,c} = c/0.5 * (C_{Rd,c} * k * (100 * \rho * f_{ck})^{1/3} = 0.12 * \sigma_{cp}) * b_w * d$

Equation 6.2b  $V_{Rd,c} = c/0.5 * (v_{min} + 0.12 * \sigma_{cp}) * b_w * d$

$$V_{Rd,c} = \max(6.2a; 6.2b)$$

With  $C_{Rd,c} = 0.15 / \gamma_c$

$$= 0.1$$

$f_{ck} = 30 \text{ MN/m}^2$

$$v_{min} = (0.0525 / \gamma_c) * k^{3/2} * f_{ck}^{1/2} \text{ for } d \leq 600 \text{ mm}$$

$$\alpha_{ct} = 0.85$$

$$\gamma_c = 1.5$$

$$f_{ctk,0.05} = 2.03 \text{ MN/m}^2$$

Assumptions: Data sheet Reverse bending Case d

$$\sigma_{cp} = 0 \quad b_w = 1.0 \text{ m}$$

Calculation of reinforcement degree P1 [10E-3]

Box width B =	85 mm	115 mm	145 mm	175 mm	205 mm	225 mm
d=	72.5 mm	102.5 mm	132.5 mm	162.5 mm	192.5 mm	212.5 mm
k =	2	2	2	2	2	1,97014

$\emptyset$ – Partition [mm]						
8 - 250	0.00277	0.00196	0.00512	0.00124	0.00104	0.00095
8 - 200	0.00347	0.00245	0.0019	0.00155	0.00131	0.00118
8 - 150	0.00462	0.00327	0.00253	0.00206	0.00174	0.00158
8 - 100	0.00693	0.0049	0.00379	0.00309	0.00261	0.00237

10 - 250	0.00433	0.00306	0.00237	0.00193	0.00163	0.00148
10 - 200	0.00542	0.00383	0.00296	0.00242	0.00204	0.00185
10 - 150	0.00722	0.00511	0.00395	0.00322	0.00272	0.00246
10 - 100	0.001983	0.00766	0.00593	0.00483	0.00408	0.0037

12 - 250	0.00624	0.00441	0.00341	0.00278	0.00235	0.00213
12 - 200	0.0078	0.00552	0.00427	0.00348	0.00294	0.00266
12 - 150	0.0104	0.00736	0.00569	0.00464	0.00392	0.00355
12 - 100	0.0156	0.01103	0.00854	0.00696	0.00588	0.00532

Prüfamt für Standsicherheit  
**LGA**  
Zweigstelle Landshut

S-LA of

# Non-certified translation from the German original.

Fritsche Ingenieure

Ingenieurbüro für Bauwesen

Page 95

## Calculation $V_{Rd,c}$ [kN/m]

Box width B =	85 mm	115 mm	145 mm	175 mm	205 mm	225 mm
d =	72.5 mm	102.5 mm	132.5 mm	162.5 mm	192.5 mm	212.5 mm
k =	2	2	2	2	2	1.97014
$V_{Rd,c,min}$	15.72 kN/m	22.23 kN/m	28.74 kN/m	35.24 kN/m	41.75 kN/m	45.06 kN/m

h=	350 mm	350 mm	350 mm	350 mm	350 mm	350 mm
----	--------	--------	--------	--------	--------	--------

Ø - Partition [mm]						
8 - 250	15.72	22.23	28.74	35.24	41.75	45.06
8 - 200	15.72	22.23	28.74	35.24	41.75	45.06
8 - 150	15.72	22.23	28.74	35.24	41.75	45.06
8 - 100	15.95	22.23	28.74	35.24	41.75	45.06

h=	430 mm	430 mm	430 mm	430 mm	430 mm	430 mm
10 - 250	15.72	22.23	28.74	35.24	41.75	45.06
10 - 200	15.72	22.23	28.74	35.24	41.75	45.06
10 - 150	16.17	22.23	28.74	35.24	41.75	45.06
10 - 100	18.51	22.23	28.74	35.24	41.75	45.06

h=	510 mm	510 mm	510 mm	510 mm	510 mm	510 mm
12 - 250	15.72	22.23	28.74	35.24	41.75	45.06
12 - 200	16.59	22.23	28.74	35.24	41.75	45.06
12 - 150	18.26	23.00	28.74	35.24	41.75	45.06
12 - 100	20.90	26.33	31.24	35.80	41.75	45.06

## Calculation rec. $L_b$ [mm]

d=	72.5 mm	102.5 mm	132.5 mm	162.5 mm	192.5 mm	212.5 mm
----	---------	----------	----------	----------	----------	----------

h=	350 mm	350 mm	350 mm	350 mm	350 mm	350 mm
----	--------	--------	--------	--------	--------	--------

Ø - Partition [mm]						
8 - 250	80	80	80	90	106	116
8 - 200	80	80	80	80	85	92
8 - 150	80	80	80	80	80	80
8 - 100	80	80	80	80	80	80

h=	430 mm	430 mm	430 mm	430 mm	430 mm	430 mm
10 - 250	100	100	100	100	100	100
10 - 200	100	100	100	100	100	100
10 - 150	100	100	100	100	100	100
10 - 100	100	100	100	100	100	100

h=	510 mm	510 mm	510 mm	510 mm	510 mm	510 mm
12 - 250	120	120	120	120	120	120
12 - 200	120	120	120	120	120	120
12 - 150	120	120	120	120	120	120
12 - 100	120	120	120	120	120	120

Prüfamt für Standsicherheit  
**LGA**

Zweigstelle Landshut

S-LA

of

# Non-certified translation from the German original.

Fritsche Ingenieure  
Ingenieurbüro für Bauwesen

Result

$V_{Rd}$	[kN/m]	Concrete quality	C30/37
Transverse force vertical - Case d data sheet Reverse bending to EC 2, Fig. 8			
Data sheet reverse bending figure 8d			
Good bond conditions according to DIN EN 1992-1-1			
$\sigma_{cd}$	=	0	$b_w = 1.0 \text{ m}$
Nevoga Plexus Type DD			

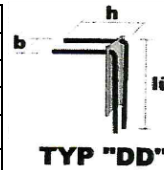

Box width	85 mm	115 mm	145 mm	175 mm	205 mm	225 mm
B=						
d=	72.5 mm	102.5 mm	132.5 mm	162.5 mm	192.5 mm	212.5 mm

h=	350 mm	350 mm	350 mm	350 mm	350 mm	350 mm	
$\emptyset$ - Partition [mm]							
8 - 250	15.72	22.23	28.74	35.24	41.75	45.06	L <sub>s</sub> = 320 mm
8 - 200	15.72	22.23	28.74	35.24	41.75	45.06	
8 - 150	15.72	22.23	28.74	35.24	41.75	45.06	
8 - 100	15.95	22.23	28.74	35.24	41.75	45.06	

h=	430 mm	430 mm	430 mm	430 mm	430 mm	430 mm	L <sub>s</sub> = 390 mm
10 - 250	15.72	22.23	28.74	35.24	41.75	45.06	
10 - 200	15.72	22.23	28.74	35.24	41.75	45.06	
10 - 150	16.17	22.23	28.74	35.24	41.75	45.06	
10 - 100	18.51	23.32	28.74	35.24	41.75	45.06	

h=	510 mm	510 mm	510 mm	510 mm	510 mm	510 mm	L <sub>s</sub> = 460 mm
12 - 250	15.72	22.23	28.74	35.24	41.75	45.06	
12 - 200	16.59	22.23	28.74	35.24	41.75	45.06	
12 - 150	18.26	23.00	28.74	35.24	41.75	45.06	
12 - 100	20.90	26.33	31.24	35.80	41.75	45.06	

The verification of the pull-out lengths in construction section 2 must be carried out by the user!  
The tensile force cover must be verified by the user in the pull-out area of the reverse bend connection!  
According to DIN EN 1992-1-1, section 9.3.1.2, paragraph (1), at least half of the field reinforcement of solid slabs must be guided to the support and anchored there!

[www.nevoga.de](http://www.nevoga.de)  
NEVOGA GmbH – Znaimer Str. 4 – D-83395 Freilassing – Telephone: 0049/8654/47310 – Fax: 0049/8654/4731 - 18

Prüfamt für Standsicherheit  
**LGA**  
Zweigstelle Landshut  
S-LA of

**Non-certified translation from the German original.**

Author Program:	Fritsche Ingenieure	Ingenieurbüro für Bauwesen Deggendorf	
Building structure : NEVOGA Plexus reinforcement connection			Date 08/2013
9. <u>Calculation of shearing force that can be absorbed Case e</u>			
<div style="border: 1px solid green; padding: 5px; width: fit-content; margin: 0 auto;">Prüfamt für Standsicherheit <b>LGA</b> Zweigstelle Landshut S-LA of</div>			
Component: Load capacity calculation EC 2 Block: according to DBV data sheet 01/2011 page: 97 ..... Process:			ARCHIVE NO.:

## Non-certified translation from the German original.

Fritsche Ingenieure

Ingenieurbüro für Bauwesen

Load tables Nevoga Plexus reinforcement connections

Page 98

Absorbable shearing force transverse to the concrete joint (case e) without transverse force reinforcement

$$\text{Formula 6.2a } V_{Rd,c} = c/0.5 * (C_{Rd,c} * k * (100 * \rho * f_{ck})^{1/3} = 0.12 * \sigma_{cp}) * b_x * d$$

$$\text{Formula 6.2b } V_{Rd,c} = c/0.5 * (v_{min} + 0.12 * \sigma_{cp}) * b_w * d$$

$$V_{Rd,c} = \max(6.2a; 6.2b)$$

With  $C_{Rd,c} = 0.15 / \gamma_c$

$$= 0.1$$

$$f_{ck} = 20 \text{ MN/m}^2$$

$$v_{min} = (0.0525 / \gamma_c) * k^{3/2} * f_{ck}^{1/2} \text{ for } d \leq 600 \text{ mm}$$

$$\alpha_{ct} = 0.85$$

$$\gamma_c = 1.5$$

$$f_{ctk,0.05} = 1.55 \text{ MN/m}^2$$

Assumptions: Data sheet Reverse bending Case e

$$\sigma_{cp} = 0 \quad b_w = 1.0 \text{ m}$$

Calculation of reinforcement degree P1 [10E-3]

Box width B=	85 mm	115 mm	145 mm	175 mm	205 mm	225 mm
d=	72.5 mm	102.5 mm	132.5 mm	162.5 mm	192.5 mm	212.5 mm
k =	2	2	2	2	2	1.97014

∅ – Partition [mm]						
8 - 250	0.00277	0.00196	0.00512	0.00124	0.00104	0.00095
8 - 200	0.00347	0.00245	0.0019	0.00155	0.00131	0.00118
8 - 150	0.00462	0.00327	0.00253	0.00206	0.00174	0.00158
8 - 100	0.00693	0.0049	0.00379	0.00309	0.00261	0.00237

10 - 250	0.00433	0.00306	0.00237	0.00193	0.00163	0.00148
10 - 200	0.00542	0.00383	0.00296	0.00242	0.00204	0.00185
10 - 150	0.00722	0.00511	0.00395	0.00322	0.00272	0.00246
10 - 100	0.01083	0.00766	0.00593	0.00483	0.00408	0.0037

12 - 250	0.00624	0.00441	0.00341	0.00278	0.00235	0.00213
12 - 200	0.0078	0.00552	0.00427	0.00348	0.00294	0.00266
12 - 150	0.0104	0.00736	0.00569	0.00464	0.00392	0.00355
12 - 100	0.0156	0.01103	0.00854	0.00696	0.00588	0.00532

Prüfamt für Standsicherheit

**LGA**

Zweigstelle Landshut

S-LA

of



Calculation  $V_{Rd,c}$  [kN/m]

Box width B=	85 mm	115 mm	145 mm	175 mm	205 mm	225 mm
d=	72.5 mm	102.5 mm	132.5 mm	162.5 mm	192.5 mm	212.5 mm
k =	2	2	2	2	2	1.97014
$V_{Rd,c,min}$	12.84 kN/m	18.15 kN/m	23.46 kN/m	28.78 kN/m	34.09 kN/m	36.79 kN/m

h=	150 mm	150 mm	150 mm	150 mm	150 mm	150 mm
∅ – Partition [mm]						
8 - 250	12.84	18.15	23.46	28.78	34.09	36.79
8 – 200	12.84	18.15	23.46	28.78	34.09	36.79
8 – 150	12.84	18.15	23.46	28.78	34.09	36.79
8 – 100	12.84	18.15	23.46	28.78	34.09	36.79

h=	150 mm	150 mm	150 mm	150 mm	150 mm	150 mm
10 - 250	12.84	18.15	23.46	28.78	34.09	36.79
10 – 200	12.84	18.15	23.46	28.78	34.09	36.79
10 – 150	14.13	18.15	23.46	28.78	34.09	36.79
10 – 100	16.17	20.37	24.17	28.78	34.09	36.79

h=	170 mm	170 mm	170 mm	170 mm	170 mm	170 mm
12 - 250	13.45	18.15	23.46	28.78	34.09	36.79
12 – 200	14.49	18.26	23.46	28.78	34.09	36.79
12 – 150	15.95	20.09	23.84	28.78	34.09	36.79
12 – 100	18.26	23.00	27.29	31.27	35.01	36.84

Calculation rec.  $L_b$  [mm]

d=	72.5 mm	102.5 mm	132.5 mm	162.5 mm	192.5 mm	212.5 mm
----	------------	-------------	-------------	-------------	-------------	----------

h=	150 mm	150 mm	150 mm	150 mm	150 mm	150 mm
∅ – Partition [mm]						
8 - 250	80	80	80	96	114	123
8 – 200	80	80	80	80	91	98
8 – 150	80	80	80	80	80	80
8 – 100	80	80	80	80	80	80

h=	150 mm	150 mm	150 mm	150 mm	150 mm	150 mm
10 - 250	100	100	100	100	100	100
10 – 200	100	100	100	100	100	100
10 – 150	100	100	100	100	100	100
10 – 100	100	100	100	100	100	100

h=	170 mm	170 mm	170 mm	170 mm	170 mm	170 mm
12 - 250	120	120	120	120	120	120
12 – 200	120	120	120	120	120	120
12 – 150	120	120	120	120	120	120
12 – 100	120	120	120	120	120	120

Prüfamt für Standsicherheit  
**LGA**  
Zweigstelle Landshut  
S-LA of

# Non-certified translation from the German original.

Fritsche Ingenieure

Ingenieurbüro für Bauwesen

Result

$V_{Rd}$	[kN/m]	Concrete quality	C20/25
Transverse force vertical - Case d data sheet Reverse bending to EC 2, Fig. 8			
Data sheet reverse bending figure 8e			
Good bond conditions according to DIN EN 1992-1-1			
$\sigma_{cd}$	=	0	$b_w = 1.0$ m
Nevoga Plexus Type B			

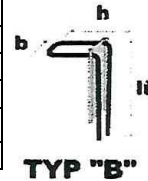

Box width B=	85 mm	115 mm	145 mm	175 mm	205 mm	225 mm
d=	72.5 mm	102.5 mm	132.5 mm	162.5 mm	192.5 mm	212.5 mm

h=	150 mm	150 mm	150 mm	150 mm	150 mm	150 mm	
Ø - Partition [mm]							
8 - 250	12.84	18.15	23.46	28.78	34.09	36.79	L <sub>s</sub> = 320 mm
8 - 200	12.84	18.15	23.46	28.78	34.09	36.79	
8 - 150	12.84	18.15	23.46	28.78	34.09	36.79	
8 - 100	13.93	18.15	23.46	28.78	34.09	36.79	

h=	150 mm	150 mm	150 mm	150 mm	150 mm	150 mm	L <sub>s</sub> = 390 mm
10 - 250	12.84	18.15	23.46	28.78	34.09	36.79	
10 - 200	12.84	18.15	23.46	28.78	34.09	36.79	
10 - 150	14.13	18.15	23.46	28.78	34.09	36.79	
10 - 100	16.17	20.37	24.17	28.78	34.09	36.79	

h=	170 mm	170 mm	170 mm	170 mm	170 mm	170 mm	L <sub>s</sub> = 460 mm
12 - 250	Production technically not possible	18.15	23.46	28.78	34.09	36.79	
12 - 200		18.26	23.46	28.78	34.09	36.79	
12 - 150		20.09	23.84	28.78	34.09	36.79	
12 - 100		23.00	27.29	31.27	35.01	36.84	

The verification of the pull-out lengths in construction section 2 must be carried out by the user!  
 The tensile force cover must be verified by the user in the pull-out area of the reverse bend connection!  
 According to DIN EN 1992-1-1, section 9.3.1.2, paragraph (1), at least half of the field reinforcement of solid slabs must be guided to the support and anchored there!

[www.nevoga.de](http://www.nevoga.de)  
 NEVOGA GmbH – Znaimer Str. 4 – D-83395 Freilassing – Telephone: 0049/8654/47310 – Fax: 0049/8654/4731 - 18

Prüfamt für Standsicherheit  
**LGA**  
 Zweigstelle Landshut  
 S-LA of

## Non-certified translation from the German original.

Page 101

Load tables Nevoga Plexus reinforcement connections

Absorbable shearing force transverse to the concrete joint (case e) without transverse force reinforcement

$$\text{Equation 6.8 } V_{Rd,s} = A_{sw} / S * z * f_{ywd} * \cot\Theta$$

$$\text{Equation 6.9 } V_{Rd,max} = 0.3 * b_w * z * v_1 * f_{cd} / \cot\Theta + \tan\Theta$$

$$V_{Rd,c} = \min (6.8;6.9)$$

With  $V_1 = 0.75 * (1.1 - f_{ck}/500) \leq 0,75$

$$= 0.75$$

$$f_{ck} = 20 \quad \text{MN/m}^2$$

$$f_{yk} = 500 \quad \text{MN/m}^2$$

$$\gamma_c = 1.5$$

$$f_{ck,0.05} = 1.55 \text{ MN/m}^2$$

Assumptions: Data sheet Reverse bending Case e

$$\sigma_{cp} = 0 \quad b_w = 1.0 \text{ m}$$

Concrete quality C20/25

[www.Nevoga.de](http://www.Nevoga.de)

**Non-certified translation from the German original.**

Fritsche Ingenieure

Ingenieurbüro für Bauwesen

Calculation  $V_{Rd,c}$  [kN/m]

Box width B=	85 mm	115 mm	145 mm	175 mm	205 mm	225 mm
d=	72.5 mm	102.5 mm	132.5 mm	162.5 mm	192.5 mm	212.5 mm
z =	7.5	37.5	67.5	97.5	127.5	147.5

h=	150 mm	150 mm	150 mm	150 mm	150 mm	150 mm
Ø – Partition [mm]						
8 - 250	9.41	47.03	84.65	122.27	159.90	184.98
8 - 200	9.41	47.03	84.65	122.27	159.90	184.98
8 - 150	9.41	47.03	84.65	122.27	159.90	184.98
8 - 100	9.41	47.03	84.65	122.27	159.90	184.98

h=	150 mm	150 mm	150 mm	150 mm	150 mm	150 mm
10 - 250	9.41	47.03	84.65	122.27	159.90	184.98
10 - 200	9.41	47.03	84.65	122.27	159.90	184.98
10 - 150	9.41	47.03	84.65	122.27	159.90	184.98
10 - 100	9.41	47.03	84.65	122.27	159.90	184.98

h=	170 mm	170 mm	170 mm	170 mm	170 mm	170 mm
12 - 250	9.41	47.03	84.65	122.27	159.90	184.98
12 - 200	9.41	47.03	84.65	122.27	159.90	184.98
12 - 150	9.41	47.03	84.65	122.27	159.90	184.98
12 - 100	9.41	47.03	84.65	122.27	159.90	184.98

Calculation rec.  $L_b$  [mm]

d=	72.5 mm	102.5 mm	132.5 mm	162.5 mm	192.5 mm	212.5 mm
----	------------	-------------	-------------	-------------	-------------	----------

h=	150 mm	150 mm	150 mm	150 mm	150 mm	150 mm
Ø – Partition [mm]						
8 - 250	80	85	152	220	288	333
8 - 200	80	80	122	176	230	266
8 - 150	80	80	91	132	173	200
8 - 100	80	80	80	88	115	133

h=	150 mm	150 mm	150 mm	150 mm	150 mm	150 mm
10 - 250	100	100	122	176	230	266
10 - 200	100	100	100	141	184	213
10 - 150	100	100	100	106	138	160
10 - 100	100	100	100	100	100	107

h=	170 mm	170 mm	170 mm	170 mm	170 mm	170 mm
12 - 250	120	120	120	147	192	222
12 - 200	120	120	120	120	154	178
12 - 150	120	120	120	120	120	133
12 - 100	120	120	120	120	120	120

Prüfamt für Standsicherheit  
**LGA**  
Zweigstelle Landshut

S-LA

of

# Non-certified translation from the German original.

Fritsche Ingenieure

Ingenieurbüro für Bauwesen

Result

$V_{Rd}$	[kN/m]	Concrete quality	C20/25
Transverse force vertical - Case e data sheet Reverse bending to EC 2, Fig. 8			
Data sheet reverse bending figure 8e with transverse force reinforcement			
Good bond conditions according to DIN EN 1992-1-1			
$\sigma_{cd}$	= 0	$b_w$	= 1.0 m
		$C_{nom}$	= 35 mm
Nevoga Plexus Type B			



Box width	85 mm	115 mm	145 mm	175 mm	205 mm	225 mm
B=						
d=	72.5 mm	102.5 mm	132.5 mm	162.5 mm	192.5 mm	212.5 mm

h=	150 mm	150 mm	150 mm	150 mm	150 mm	150 mm	
Ø - Partition [mm]							
8 - 250	Transverse force reinforcement does not increase the load carrying capacity	47.03	83.33	83.33	83.33	83.33	L <sub>s</sub> = 320 mm
8 - 200		47.03	84.65	104.16	104.16	104.16	
8 - 150		47.03	84.65	122.27	138.88	138.88	
8 - 100		47.03	84.65	122.27	159.90	184.98	

h=	150 mm	150 mm	150 mm	150 mm	150 mm	150 mm	L <sub>s</sub> = 390 mm
10 - 250	Transverse force reinforcement does not increase the load carrying capacity	47.03	84.65	104.16	104.16	104.16	
10 - 200		47.03	84.65	122.27	130.20	130.20	
10 - 150		47.03	84.65	122.27	159.90	173.61	
10 - 100		47.03	84.65	122.27	159.90	184.98	

h=	170 mm	170 mm	170 mm	170 mm	170 mm	170 mm	
12 - 250	Transverse force reinforcement does not increase the load carrying capacity	47.03	84.65	122.27	141.66	141.66	L <sub>s</sub> = 460 mm
12 - 200		47.03	84.65	122.27	159.90	177.08	
12 - 150		47.03	84.65	122.27	159.90	184.98	
12 - 100		47.03	84.65	122.27	159.90	184.98	

The required transverse force reinforcement for vertical stirrups shall be calculated assuming  $\cot \theta = 1$  according to the following equation:  $\text{erf. } a_{sw} = V_{ed} / (f_{ywd} * z)$   
 The verification of the pull-out lengths in construction section 2 must be carried out by the user!  
 The tensile force cover must be verified by the user in the pull-out area of the reverse bend connection!  
 According to DIN EN 1992-1-1, section 9.3.1.2, paragraph (1), at least half of the field reinforcement of solid slabs must be guided to the support and anchored there!

## Non-certified translation from the German original.

Fritsche Ingenieure  
Ingenieurbüro für Bauwesen

Page 104

Load tables Nevoga Plexus reinforcement connections

Absorbable shearing force transverse to the concrete joint (case e) without transverse force reinforcement

Formula 6.2a  $V_{Rd,c} = c/0.5 * (C_{Rd,c} * k * (100 * \pi * f_{ck})^{1/3} + 0.12 * \sigma_{cp}) * b_w * d$

Formula 6.2b  $V_{Rd,c} = c/0.5 * (v_{min} + 0.12 * \sigma_{cp}) * b_w * d$

$$V_{Rd,c} = \max(6.2a; 6.2b)$$

With  $C_{Rd,c} = 0.15 / \gamma_c$

$$= 0.1$$

$f_{ck} = 25 \text{ MN/m}^2$

$$v_{min} = (0.0525 / \gamma_c) * k^{3/2} * f_{ck}^{1/2} \quad \text{for } d \leq 600 \text{ mm}$$

$$\alpha_{ct} = 0.85$$

$$\gamma_c = 1.5$$

$$f_{ctk,0.05} = 1,80 \text{ MN/m}^2$$

Assumptions: Data sheet Reverse bending Case e

$$\sigma_{cp} = 0 \quad b_w = 1.0 \text{ m}$$

Calculation of reinforcement degree P1 [10E-3]

Box width	85 mm	115 mm	145 mm	175 mm	205 mm	225 mm
d=	72.5 mm	102.5 mm	132.5 mm	162.5 mm	192.5 mm	212.5 mm
k =	2	2	2	2	2	1.97014

$\emptyset$ - Partition [mm]						
8 - 250	0.00277	0.00196	0.00152	0.00124	0.00104	0.00095
8 - 200	0.00347	0.00245	0.0019	0.00155	0.00131	0.00118
8 - 150	0.00462	0.00327	0.00253	0.00206	0.00174	0.00158
8 - 100	0.00693	0.0049	0.00379	0.00309	0.00261	0.00237

10 - 250	0.00433	0.00306	0.00237	0.00193	0.00163	0.00148
10 - 200	0.00542	0.00383	0.00296	0.00242	0.00204	0.00185
10 - 150	0.00722	0.00511	0.00395	0.00322	0.00272	0.00246
10 - 100	0.01083	0.00766	0.00593	0.00483	0.00408	0.0037

12 - 250	0.00624	0.00441	0.00341	0.00278	0.00235	0.00213
12 - 200	0.0078	0.00552	0.00427	0.00348	0.00294	0.00266
12 - 150	0.0104	0.00736	0.00569	0.00464	0.00392	0.00355
12 - 100	0.0156	0.01103	0.00854	0.00696	0.00588	0.00532

Prüfamt für Standsicherheit  
**LGA**  
Zweigstelle Landshut  
S-LA of

**Non-certified translation from the German original.**

Fritsche Ingenieure

Ingenieurbüro für Bauwesen

Calculation  $V_{Rd,c}$  [kN/m]

Box width B=	85 mm	115 mm	145 mm	175 mm	205 mm	225 mm
d=	72.5 mm	102.5 mm	132.5 mm	162.5 mm	192.5 mm	212.5 mm
k =	2	2	2	2	2	1.97014
$V_{Rd,c,min}$	14.35 kN/m	20.29 kN/m	26.23 kN/m	32.17 kN/m	38.11 kN/m	41.13 kN/m

h=	150 mm	150 mm	150 mm	150 mm	150 mm	150 mm
----	--------	--------	--------	--------	--------	--------

Ø – Partition [mm]						
8 - 250	14.35	20.29	26.23	32.17	38.11	41.13
8 - 200	14.35	20.29	26.23	32.17	38.11	41.13
8 - 150	14.35	20.29	26.23	32.17	38.11	41.13
8 - 100	15.01	20.29	26.23	32.17	38.11	41.13

h=	150 mm	150 mm	150 mm	150 mm	150 mm	150 mm
10 - 250	14.35	20.29	26.23	32.17	38.11	41.13
10 - 200	14.35	20.29	26.23	32.17	38.11	41.13
10 - 150	15.22	20.29	26.23	32.17	38.11	41.13
10 - 100	17.42	21.94	26.23	32.17	38.11	41.13

h=	170 mm	170 mm	170 mm	170 mm	170 mm	170 mm
12 - 250	14.49	20.29	26.23	32.17	38.11	41.13
12 - 200	15.61	20.29	26.23	32.17	38.11	41.13
12 - 150	17.18	21.64	26.23	32.17	38.11	41.13
12 - 100	19.67	24.78	29.40	33.69	38.11	41.13

Calculation rec.  $L_b$  [mm]

d=	72.5 mm	102.5 mm	132.5 mm	162.5 mm	192.5 mm	212.5 mm
----	---------	----------	----------	----------	----------	----------

h=	150 mm	150 mm	150 mm	150 mm	150 mm	150 mm
Ø – Partition [mm]						
8 - 250	80	80	80	92	109	118
8 - 200	80	80	80	80	88	95
8 - 150	80	80	80	80	80	80
8 - 100	80	80	80	80	80	80

h=	150 mm	150 mm	150 mm	150 mm	150 mm	150 mm
10 - 250	100	100	100	100	100	100
10 - 200	100	100	100	100	100	100
10 - 150	100	100	100	100	100	100
10 - 100	100	100	100	100	100	100

h=	170 mm	170 mm	170 mm	170 mm	170 mm	170 mm
12 - 250	120	120	120	120	120	120
12 - 200	120	120	120	120	120	120
12 - 150	120	120	120	120	120	120
12 - 100	120	120	120	120	120	120

Prüfamt für Standsicherheit  
**LGA**  
Zweigstelle Landshut

S-LA

of

**Non-certified translation from the German original.**

Result

$V_{Rd}$	[kN/m]	Concrete quality	C25/30
Transverse force vertical - Case d data sheet Reverse bending to EC 2, Fig. 8			
Data sheet reverse bending figure 8e			
Good bond conditions according to DIN EN 1992-1-1			
$\sigma_{cd}$	=	0	$b_w = 1.0 m$
Nevoga Plexus Type B			

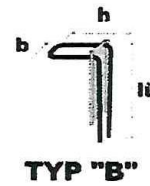

Box width	85 mm	115 mm	145 mm	175 mm	205 mm	225 mm
B=						
d=	72.5 mm	102.5 mm	132.5 mm	162.5 mm	192.5 mm	212.5 mm

h=	150 mm	150 mm	150 mm	150 mm	150 mm	150 mm	
----	--------	--------	--------	--------	--------	--------	--

$\emptyset$ - Partition [mm]							
8 - 250	14.35	20.29	26.23	32.17	38.11	41.13	L <sub>s</sub> = 320 mm
8 - 200	14.35	20.29	26.23	32.17	38.11	41.13	
8 - 150	14.35	20.29	26.23	32.17	38.11	41.13	
8 - 100	14.35	20.29	26.23	32.17	38.11	41.13	

h=	150 mm	150 mm	150 mm	150 mm	150 mm	150 mm	L <sub>s</sub> = 390 mm
10 - 250	14.35	20.29	26.23	32.17	38.11	41.13	
10 - 200	14.35	20.29	26.23	32.17	38.11	41.13	
10 - 150	15.22	20.29	26.23	32.17	38.11	41.13	
10 - 100	17.42	21.94	26.23	32.17	38.11	41.13	

h=	150 mm	150 mm	150 mm	150 mm	150 mm	150 mm	L <sub>s</sub> = 460 mm
12 - 250	Production technically not possible	20.29	26.23	32.17	38.11	41.13	
12 - 200		20.29	26.23	32.17	38.11	41.13	
12 - 150		21.64	26.23	32.17	38.11	41.13	
12 - 100		24.78	29.40	33.69	38.11	41.13	

The verification of the pull-out lengths in construction section 2 must be carried out by the user!  
The tensile force cover must be verified by the user in the pull-out area of the reverse bend connection!  
According to DIN EN 1992-1-1, section 9.3.1.2, paragraph (1), at least half of the field reinforcement of solid slabs must be guided to the support and anchored there!

[www.nevoga.de](http://www.nevoga.de)

NEVOGA GmbH – Znaimer Str. 4 – D-83395 Freilassing – Telephone: 0049/8654/47310 – Fax: 0049/8654/4731 - 18

Prüfamt für Standsicherheit  
**LGA**  
Zweigstelle Landshut

S-LA of



## Non-certified translation from the German original.

Page 107

Load tables Nevoga Plexus reinforcement connections

Absorbable shearing force transverse to the concrete joint (case e) with transverse force reinforcement

$$\text{Equation 6.8} \quad V_{Rd,s} = A_{sw} / S) * z * f_{ywd} * \cot\Theta$$

$$\text{Equation 6.9} \quad V_{Rd,max} = 0.3 * b_w * z * v_1 * f_{cd} / \cot\Theta + \tan\Theta$$

$$V_{Rd,c} = \min(6.8; 6.9)$$

$$\text{With} \quad V_1 = 0.75 * (1.1 - f_{ck}/500) \leq 0.75$$

$$= 0.75$$

$$f_{ck} = 25 \quad \text{MN/m}^2$$

$$f_{yk} = 500 \quad \text{MN/m}^2$$

$$\gamma_c = 1.5$$

$$f_{ck,0.05} = 1.80 \text{ MN/m}^2$$

Assumptions: Data sheet Reverse bending Case e

$$\sigma_{cp} = 0 \quad b_w = 1.0 \text{ m}$$

Concrete quality C25/30

[www.Nevoga.de](http://www.Nevoga.de)

**Non-certified translation from the German original.**

Fritsche Ingenieure  
Ingenieurbüro für Bauwesen

Calculation  $V_{Rd,c}$  [kN/m]

Box width B=	85 mm	115 mm	145 mm	175 mm	205 mm	225 mm
d=	72.5 mm	102.5 mm	132.5 mm	162.5 mm	192.5 mm	212.5 mm
z =	7.5	37.5	67.5	97.5	127.5	147.5

h=	150 mm	150 mm	150 mm	150 mm	150 mm	150 mm
∅ – Partition [mm]						
8 - 250	11.76	58.79	105.81	152.84	199.87	231.22
8 – 200	11.76	58.79	105.81	152.84	199.87	231.22
8 – 150	11.76	58.79	105.81	152.84	199.87	231.22
8 – 100	11.76	58.79	105.81	152.84	199.87	231.22

h=	150 mm	150 mm	150 mm	150 mm	150 mm	150 mm
10 - 250	11.76	58.79	105.81	152.84	199.87	231.22
10 – 200	11.76	58.79	105.81	152.84	199.87	231.22
10 – 150	11.76	58.79	105.81	152.84	199.87	231.22
10 – 100	11.76	58.79	105.81	152.84	199.87	231.22

h=	170 mm	170 mm	170 mm	170 mm	170 mm	170 mm
12 - 250	11.76	58.79	105.81	152.84	199.87	231.22
12 – 200	11.76	58.79	105.81	152.84	199.87	231.22
12 – 150	11.76	58.79	105.81	152.84	199.87	231.22
12 – 100	11.76	58.79	105.81	152.84	199.87	231.22

Calculation rec.  $L_b$  [mm]

d=	72.5 mm	102.5 mm	132.5 mm	162.5 mm	192.5 mm	212.5 mm
----	------------	-------------	-------------	-------------	-------------	----------

h=	150 mm	150 mm	150 mm	150 mm	150 mm	150 mm
∅ – Partition [mm]						
8 - 250	80	91	164	237	310	359
8 – 200	80	80	131	190	248	287
8 – 150	80	80	98	142	186	215
8 – 100	80	80	80	95	124	143

h=	150 mm	150 mm	150 mm	150 mm	150 mm	150 mm
10 - 250	100	100	131	190	248	287
10 – 200	100	100	105	152	198	230
10 – 150	100	100	100	114	149	172
10 – 100	100	100	100	100	100	115

h=	170 mm	170 mm	170 mm	170 mm	170 mm	170 mm
12 - 250	120	120	120	158	207	239
12 – 200	120	120	120	126	165	191
12 – 150	120	120	120	120	124	143
12 – 100	120	120	120	120	120	120

Prüfamt für Standsicherheit  
LGA  
Zweigstelle Landshut  
S-LA of

# Non-certified translation from the German original.

Fritsche Ingenieure  
Ingenieurbüro für Bauwesen

Result

$V_{Rd}$	[kN/m]	Concrete quality	C25/30
Transverse force vertical - Case e data sheet Reverse bending to EC 2, Fig. 8			
Data sheet reverse bending figure 8e with transverse force reinforcement			
Good bond conditions according to DIN EN 1992-1-1			
$\sigma_{cd}$	= 0	$b_w$	= 1.0 m
		$C_{nom}$	= 35 mm
Nevoga Plexus Type B			

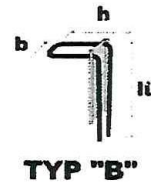

Box width	85 mm	115 mm	145 mm	175 mm	205 mm	225 mm
B=						
d=	72.5 mm	102.5 mm	132.5 mm	162.5 mm	192.5 mm	212.5 mm

h=	150 mm	150 mm	150 mm	150 mm	150 mm	150 mm	
∅ - Partition [mm]							
8 - 250	Transverse force reinforcement does not increase the load carrying capacity	58.79	96.70	96.70	96.70	96.70	L <sub>s</sub> = 320 mm
8 - 200		58.79	105.81	120.87	120.87	120.87	
8 - 150		58.79	105.81	152.84	161.16	161.16	
8 - 100		58.79	105.81	152.84	199.87	231.22	

h=	150 mm	150 mm	150 mm	150 mm	150 mm	150 mm	L <sub>s</sub> = 390 mm
10 - 250	Transverse force reinforcement does not increase the load carrying capacity	58.79	105.81	120.87	120.87	120.87	
10 - 200		58.79	105.81	151.09	151.09	151.09	
10 - 150		58.79	105.81	152.84	199.87	201.45	
10 - 100		58.79	105.81	152.84	199.87	231.22	

h=	170 mm	170 mm	170 mm	170 mm	170 mm	170 mm	
12 - 250	Transverse force reinforcement does not increase the load carrying capacity	58.79	105.81	152.84	164.38	164.38	L <sub>s</sub> = 460 mm
12 - 200		58.79	105.81	152.84	199.87	205.48	
12 - 150		58.79	105.81	152.84	199.87	231.22	
12 - 100		58.79	105.81	152.84	199.87	231.22	

The required transverse force reinforcement for vertical stirrups shall be calculated assuming  $\cot \theta = 1$  according to the following equation:  $a_{sw} = V_{ed} / (f_{ywd} * z)$   
 The verification of the pull-out lengths in construction section 2 must be carried out by the user!  
 The tensile force cover must be verified by the user in the pull-out area of the reverse bend connection!  
 According to DIN EN 1992-1-1, section 9.3.1.2, paragraph (1), at least half of the field reinforcement of solid slabs must be guided to the support and anchored there!

Load tables Nevoga Plexus reinforcement connections

Absorbable shearing force transverse to the concrete joint (case e) without transverse force reinforcement

Formula 6.2a  $V_{Rd,c} = c/0.5 * (C_{Rd,c} * k * (100 * \rho_i * f_{ck})^{1/3} + 0.12 * \sigma_{cp}) * b_w * d$

Formula 6.2b  $V_{Rd,c} = c/0.5 * (v_{min} + 0.12 * \sigma_{cp}) * b_w * d$

$V_{Rd,c} = \max(6.2a; 6.2b)$

With  $C_{Rd,c} = 0.15 / \gamma_c$

$= 0.1$

$f_{ck} = 30 \text{ MN/m}^2$

$v_{min} = (0.0525 / \gamma_c) * k^{3/2} * f_{ck}^{1/2}$  for  $d \leq 600 \text{ mm}$

$\alpha_{ct} = 0.85$

$\gamma_c = 1.5$

$f_{ctk,0.05} = 2.03 \text{ MN/m}^3$

Assumptions: Data sheet Reverse bending Case e

$\sigma_{cp} = 0 \quad b_w = 1.0 \text{ m}$

Calculation of reinforcement degree P1 [10E-3]

Box width	85 mm	115 mm	145 mm	175 mm	205 mm	225 mm
d=	72.5 mm	102.5 mm	132.5 mm	162.5 mm	192.5 mm	212.5 mm
k =	2	2	2	2	2	1.97014

$\emptyset$ - Partition [mm]						
8 - 250	0.00277	0.00196	0.00512	0.00124	0.00104	0.00095
8 - 200	0.00347	0.00245	0.0019	0.00155	0.00131	0.00118
8 - 150	0.00462	0.00327	0.00253	0.00206	0.00174	0.00158
8 - 100	0.00693	0.0049	0.00379	0.00309	0.00261	0.00237

10 - 250	0.00433	0.00306	0.00237	0.00193	0.00163	0.00148
10 - 200	0.00542	0.00383	0.00296	0.00242	0.00204	0.00185
10 - 150	0.00722	0.00511	0.00395	0.00322	0.00272	0.00246
10 - 100	0.01083	0.00766	0.00593	0.00483	0.00408	0.0037

12 - 250	0.00624	0.00441	0.00341	0.00278	0.00235	0.00213
12 - 200	0.0078	0.00552	0.00427	0.00348	0.00294	0.00266
12 - 150	0.0104	0.00736	0.00569	0.00464	0.00392	0.00355
12 - 100	0.0156	0.01103	0.00854	0.00696	0.00588	0.00532

Prüfamt für Standsicherheit  
**LGA**  
Zweigstelle Landshut  
S-LA of

# Non-certified translation from the German original.

Fritsche Ingenieure

Ingenieurbüro für Bauwesen

## Calculation $V_{Rd,c}$ [kN/m]

Box width	85 mm	115 mm	145 mm	175 mm	205 mm	225 mm
d=	72.5 mm	102.5 mm	132.5 mm	162.5 mm	192.5 mm	212.5 mm
k =	2	2	2	2	2	1.97014
$V_{Rd,c,min}$	15.72 kN/m	22.23 kN/m	28.74 kN/m	35.24 kN/m	41.75 kN/m	45.06 kN/m

h=	150 mm	150 mm	150 mm	150 mm	150 mm	150 mm
----	--------	--------	--------	--------	--------	--------

Ø - Partition [mm]						
8 - 250	15.72	22.23	28.74	35.24	41.75	45.06
8 - 200	15.72	22.23	28.74	35.24	41.75	45.06
8 - 150	15.72	22.23	28.74	35.24	41.75	45.06
8 - 100	15.95	22.23	28.74	35.24	41.75	45.06

h=	150 mm	150 mm	150 mm	150 mm	150 mm	150 mm
10 - 250	15.72	22.23	28.74	35.24	41.75	45.06
10 - 200	15.72	22.23	28.74	35.24	41.75	45.06
10 - 150	16.17	22.23	28.74	35.24	41.75	45.06
10 - 100	18.51	23.32	28.74	35.24	41.75	45.06

h=	170 mm	170 mm	170 mm	170 mm	170 mm	170 mm
12 - 250	15.72	22.23	28.74	35.24	41.75	45.06
12 - 200	16.59	22.23	28.74	35.24	41.75	45.06
12 - 150	18.26	23.00	28.74	35.24	41.75	45.06
12 - 100	20.90	26.33	31.24	35.80	41.75	45.06

## Calculation rec. $L_b$ [mm]

d=	72.5 mm	102.5 mm	132.5 mm	162.5 mm	192.5 mm	212.5 mm
----	---------	----------	----------	----------	----------	----------

h=	150 mm	150 mm	150 mm	150 mm	150 mm	150 mm
----	--------	--------	--------	--------	--------	--------

Ø - Partition [mm]						
8 - 250	80	80	80	90	106	115
8 - 200	80	80	80	80	85	92
8 - 150	80	80	80	80	80	80
8 - 100	80	80	80	80	80	80

h=	150 mm	150 mm	150 mm	150 mm	150 mm	150 mm
10 - 250	100	100	100	100	100	100
10 - 200	100	100	100	100	100	100
10 - 150	100	100	100	100	100	100
10 - 100	100	100	100	100	100	100

h=	170 mm	170 mm	170 mm	170 mm	170 mm	170 mm
12 - 250	120	120	120	120	120	120
12 - 200	120	120	120	120	120	120
12 - 150	120	120	120	120	120	120
12 - 100	120	120	120	120	120	120

Prüfamt für Standsicherheit

**LGA**

Zweigstelle Landshut

S-LA

of

Result

$V_{Rd}$	[kN/m]	Concrete quality	C30/37
Transverse force vertical - Case d data sheet Reverse bending to EC 2, Fig. 8			
Data sheet reverse bending figure 8e			
Good bond conditions according to DIN EN 1992-1-1			
$\sigma_{cd}$	=	0	$b_w = 1.0$ m
Nevoga Plexus Type B			

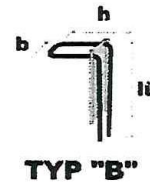

Box width	85 mm	115 mm	145 mm	175 mm	205 mm	225 mm
d=	72.5 mm	102.5 mm	132.5 mm	162.5 mm	192.5 mm	212.5 mm

h=	150 mm	150 mm	150 mm	150 mm	150 mm	150 mm	
Ø - Partition [mm]							
8 - 250	15.72	22.23	28.74	35.24	41.75	45.06	L <sub>s</sub> = 320 mm
8 - 200	15.72	22.23	28.74	35.24	41.75	45.06	
8 - 150	15.72	22.23	28.74	35.24	41.75	45.06	
8 - 100	15.95	22.23	28.74	35.24	41.75	45.06	

h=	150 mm	150 mm	150 mm	150 mm	150 mm	150 mm	L <sub>s</sub> = 390 mm
10 - 250	15.72	22.23	28.74	35.24	41.75	45.06	
10 - 200	15.72	22.23	28.74	35.24	41.75	45.06	
10 - 150	16.17	22.23	28.74	35.24	41.75	45.06	
10 - 100	18.51	23.32	28.74	35.24	41.75	45.06	

h=	170 mm	170 mm	170 mm	170 mm	170 mm	170 mm	L <sub>s</sub> = 460 mm
12 - 250	Production technically not possible	22.23	28.74	35.24	41.75	45.06	
12 - 200		22.23	28.74	35.24	41.75	45.06	
12 - 150		23.00	28.74	35.24	41.75	45.06	
12 - 100		26.33	31.24	35.80	41.75	45.06	

The verification of the pull-out lengths in construction section 2 must be carried out by the user!  
 The tensile force cover must be verified by the user in the pull-out area of the reverse bend connection!  
 According to DIN EN 1992-1-1, section 9.3.1.2, paragraph (1), at least half of the field reinforcement of solid slabs must be guided to the support and anchored there!

[www.nevoga.de](http://www.nevoga.de)

NEVOGA GmbH – Znaimer Str. 4 – D-83395 Freilassing – Telephone: 0049/8654/47310 – Fax: 0049/8654/4731 - 18

Prüfamt für Standsicherheit  
**LGA**  
 Zweigstelle Landshut

S-LA of

## Non-certified translation from the German original.

Page 113

Load tables Nevoga Plexus reinforcement connections

Absorbable shearing force transverse to the concrete joint (case e) with transverse force reinforcement

$$\text{Equation 6.8 } V_{Rd,s} = A_{sw} / S) * z * f_{ywd} * \cot\Theta$$

$$\text{Equation 6.9 } V_{Rd,max} = 0.3 * b_w * z * v_1 * f_{cd} / \cot\Theta + \tan\Theta$$

$$\text{With } V_1 = 0.75 * (1.1 - f_{ck}/500) \leq 0.75$$
$$= 0.75$$

$$f_{ck} = 30 \text{ MN/m}^2$$

$$f_{yk} = 500 \text{ MN/m}^2$$

$$\gamma_c = 1.5$$

$$f_{ck,0.05} = 2.03 \text{ MN/m}^2$$

Assumptions: Data sheet Reverse bending Case e

$$\sigma_{cp} = 0 \quad b_w = 1.0 \text{ m}$$

Concrete quality C30/37

[www.Nevoga.de](http://www.Nevoga.de)

Nevoga GmbH – Znaimer Str. 4 – D-83396 Freilassing – Telephone: 0049/8654/47310 – Fax: 0049/8654/4731- 18

**Non-certified translation from the German original.**

Fritsche Ingenieure  
Ingenieurbüro für Bauwesen

Calculation  $V_{Rd,c}$  [kN/m]

Box width B=	85 mm	115 mm	145 mm	175 mm	205 mm	225 mm
d=	72.5 mm	102.5 mm	132.5 mm	162.5 mm	192.5 mm	212.5 mm
z =	7.5	37.5	67.5	97.5	127.5	147.5

h=	150 mm	150 mm	150 mm	150 mm	150 mm	150 mm
∅ – Partition [mm]						
8 - 250	14.11	70.54	126.98	183.41	239.85	277.47
8 – 200	14.11	70.54	126.98	183.41	239.85	277.47
8 – 150	14.11	70.54	126.98	183.41	239.85	277.47
8 – 100	14.11	70.54	126.98	183.41	239.85	277.47

h=	150 mm	150 mm	150 mm	150 mm	150 mm	150 mm
10 - 250	14.11	70.54	126.98	183.41	239.85	277.47
10 – 200	14.11	70.54	126.98	183.41	239.85	277.47
10 – 150	14.11	70.54	126.98	183.41	239.85	277.47
10 – 100	14.11	70.54	126.98	183.41	239.85	277.47

h=	170 mm	170 mm	170 mm	170 mm	170 mm	170 mm
12 - 250	14.11	70.54	126.98	183.41	239.85	277.47
12 – 200	14.11	70.54	126.98	183.41	239.85	277.47
12 – 150	14.11	70.54	126.98	183.41	239.85	277.47
12 – 100	14.11	70.54	126.98	183.41	239.85	277.47

Calculation rec.  $L_b$  [mm]

d=	72.5 mm	102.5 mm	132.5 mm	162.5 mm	192.5 mm	212.5 mm
----	------------	-------------	-------------	-------------	-------------	----------

h=	150 mm	150 mm	150 mm	150 mm	150 mm	150 mm
∅ – Partition [mm]						
8 - 250	80	97	174	252	329	381
8 – 200	80	80	140	202	264	305
8 – 150	80	80	105	151	198	229
8 – 100	80	80	80	101	132	152

h=	150 mm	150 mm	150 mm	150 mm	150 mm	150 mm
10 - 250	100	100	140	202	264	305
10 – 200	100	100	112	161	211	244
10 – 150	100	100	100	121	158	183
10 – 100	100	100	100	100	105	122

h=	170 mm	170 mm	170 mm	170 mm	170 mm	170 mm
12 - 250	120	120	120	168	220	254
12 – 200	120	120	120	134	176	203
12 – 150	120	120	120	120	132	152
12 – 100	120	120	120	120	120	120

Prüfamt für Standsicherheit  
**LGA**  
Zweigstelle Landshut

S-LA

of



# Non-certified translation from the German original.

Fritsche Ingenieure  
Ingenieurbüro für Bauwesen

Result

$V_{Rd}$	[kN/m]	Concrete quality	C30/37
Transverse force vertical - Case e data sheet Reverse bending to EC 2, Fig. 8			
Data sheet reverse bending figure 8 b with transverse force reinforcement			
Good bond conditions according to DIN EN 1992-1-1			
$\sigma_{cd}$	=	0	$b_w = 1.0 \text{ m}$ $C_{nom} = 35 \text{ mm}$
Nevoga Plexus Type B			

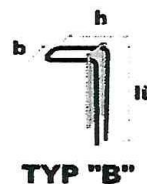

Box width	85 mm	115 mm	145 mm	175 mm	205 mm	225 mm
B=						
d=	72.5 mm	102.5 mm	132.5 mm	162.5 mm	192.5 mm	212.5 mm

h=	150 mm	150 mm	150 mm	150 mm	150 mm	150 mm	
Ø - Partition [mm]							
8 - 250	Transverse force reinforcement does not increase the load carrying capacity	70.54	109.19	109.19	109.19	109.19	$L_s = 320 \text{ mm}$
8 - 200		70.54	126.98	136.49	136.49	136.49	
8 - 150		70.54	126.98	181.99	181.99	181.99	
8 - 100		70.54	126.98	183.41	239.85	272.99	

h=	150 mm	150 mm	150 mm	150 mm	150 mm	150 mm	
10 - 250	Transverse force reinforcement does not increase the load carrying capacity	70.54	126.98	136.49	136.49	136.49	$L_s = 390 \text{ mm}$
10 - 200		70.54	126.98	170.62	170.62	170.62	
10 - 150		70.54	126.98	183.41	227.49	227.49	
10 - 100		70.54	126.98	183.41	239.85	277.47	

h=	170 mm	170 mm	170 mm	170 mm	170 mm	170 mm	
12 - 250	Transverse force reinforcement does not increase the load carrying capacity	70.54	126.98	183.41	185.63	185.63	$L_s = 460 \text{ mm}$
12 - 200		70.54	126.98	183.41	232.04	232.04	
12 - 150		70.54	126.98	183.41	239.85	277.47	
12 - 100		70.54	126.98	183.41	239.85	277.47	

The required transverse force reinforcement for vertical stirrups shall be calculated assuming  $\cot \theta = 1$  according to the following equation:  $\text{erf. } a_{sw} = V_{ed} / (f_{ywd} * z)$   
 The verification of the pull-out lengths in construction section 2 must be carried out by the user!  
 The tensile force cover must be verified by the user in the pull-out area of the reverse bend connection!  
 According to DIN EN 1992-1-1, section 9.3.1.2, paragraph (1), at least half of the field reinforcement of solid slabs must be guided to the support and anchored there!

Prüfamt für Standsicherheit  
**LGA**  
Zweigstelle Landshut  
S-LA of



## Non-certified translation from the German original.

Page 117

Load tables Nevoga Plexus reinforcement connections

Absorbable shearing force transverse to the concrete joint (case f)      without transverse force reinforcement

$$\text{Formula 6.2a } V_{Rd,c} = c/0.5 * (C_{Rd,c} * k * (100 * \rho * f_{ck})^{1/3} + 0.12 * \sigma_{cp}) * b_w * d$$

$$\text{Formula 6.2b } V_{Rd,c} = c/0.5 * (v_{min} + 0.12 * \sigma_{cp}) * b_w * d$$

$$V_{Rd,c} = \max(6.2a; 6.2b)$$

$$\text{With } C_{Rd,c} = 0.15 / \gamma_c$$

$$= 0.1$$

$$f_{ck} = 20 \quad \text{MN/m}^2$$

$$v_{min} = (0.0525 / \gamma_c) * k^{3/2} * f_{ck}^{1/2} \quad \text{for } d \leq 600 \text{ mm}$$

$$\alpha_{ct} = 0.85$$

$$\gamma_c = 1.5$$

$$f_{ctk,0.05} = 1.55 \text{ MN/m}^2$$

Assumptions:    Data sheet Reverse bending Case f

$$\sigma_{cp} = 0 \quad b_w = 1.0 \text{ m}$$

[www.Nevoga.de](http://www.Nevoga.de)

Nevoga GmbH – Znaimer Str. 4 – D-83396 Freilassing – Telephone: 0049/8654/47310 – Fax: 0049/8654/4731- 18



Calculation  $V_{Rd,c}$  [kN/m]

d=	200 mm	240 mm	250 mm	270 mm	290 mm	320 mm	330 mm	350 mm	370 mm	400 mm
k=	2	1.91287	1.89443	1.86066	1.83045	1.79057	1.7785	1.75593	1.73521	1.70711
$V_{Rd,c,min}$ [kN/m]	35.42	39.75	40.81	42.91	44.97	48.00	49.00	50.99	52.95	55.86

h=	350 mm	350 mm	350 mm	350 mm	350 mm	350 mm	350 mm	350 mm	350 mm	350 mm
∅ – Partition [mm]										
8 - 250	35.42	39.75	40.81	42.91	44.97	48.00	49.00	50.99	52.95	55.86
8 – 200	35.42	39.75	40.81	42.91	44.97	48.00	49.00	50.99	52.95	55.86
8 – 150	35.42	39.75	40.81	42.91	44.97	48.00	49.00	50.99	52.95	55.86
8 – 100	35.42	39.75	40.81	42.91	44.97	48.00	49.00	50.99	52.95	55.86

h=	430 mm	430 mm	430 mm	430 mm	430 mm	430 mm	430 mm	430 mm	430 mm	430 mm
10 - 250	35.42	39.75	40.81	42.91	44.97	48.00	49.00	50.99	52.95	55.86
10 – 200	35.42	39.75	40.81	42.91	44.97	48.00	49.00	50.99	52.95	55.86
10 – 150	35.42	39.75	40.81	42.91	44.97	48.00	49.00	50.99	52.95	55.86
10 – 100	35.42	39.75	40.81	42.91	44.97	48.00	49.00	50.99	52.95	55.86

h=	510 mm	510 mm	510 mm	510 mm	510 mm	510 mm	510 mm	510 mm	510 mm	510 mm
12 - 250	35.42	39.75	40.81	42.91	44.97	48.00	49.00	50.99	52.95	55.86
12 – 200	35.42	39.75	40.81	42.91	44.97	48.00	49.00	50.99	52.95	55.86
12 – 150	35.42	39.75	40.81	42.91	44.97	48.00	49.00	50.99	52.95	55.86
12 – 100	35.91	39.75	40.81	42.91	44.97	48.00	49.00	50.99	52.95	55.86

[www.nevoga.de](http://www.nevoga.de)  
NEVOGA GmbH – Znaimer Str. 4 – D-83395 Freilassing – Telephone: 0049/8654/47310 – Fax: 0049/8654/4731 - 18

Prüfamt für Standsicherheit  
**LGA**  
Zweigstelle Landshut  
S-LA \_\_\_\_\_ of \_\_\_\_\_

**Non-certified translation from the German original.**

Fritsche Ingenieure  
Ingenieurbüro für Bauwesen

Calculation rec.  $L_b$  [mm]

d=	200 mm	240 mm	250 mm	270 mm	290 mm	320 mm	330 mm	350 mm	370 mm	400 mm
----	--------	--------	--------	--------	--------	--------	--------	--------	--------	--------

h=	350 mm	350 mm	350 mm	350 mm	350 mm	350 mm	350 mm	350 mm	350 mm	350 mm
∅ – Partition [mm]										
8 - 250	118	133	136	143	150	160	163	170	177	186
8 – 200	94	106	109	114	120	128	131	136	141	149
8 – 150	80	80	82	86	90	96	98	102	106	112
8 – 100	80	80	80	80	80	80	80	80	80	80

h=	430 mm	430 mm	430 mm	430 mm	430 mm	430 mm	430 mm	430 mm	430 mm	430 mm
10 - 250	100	106	109	114	120	128	131	136	141	149
10 – 200	100	100	100	100	100	102	105	109	113	119
10 – 150	100	100	100	100	100	100	100	100	100	100
10 – 100	100	100	100	100	100	100	100	100	100	100

h=	510 mm	510 mm	510 mm	510 mm	510 mm	510 mm	510 mm	510 mm	510 mm	510 mm
12 - 250	120	120	120	120	120	120	120	120	120	124
12 – 200	120	120	120	120	120	120	120	120	120	120
12 – 150	120	120	120	120	120	120	120	120	120	120
12 – 100	120	120	120	120	120	120	120	120	120	120

[www.nevoga.de](http://www.nevoga.de)  
NEVOGA GmbH – Znaimer Str. 4 – D-83395 Freilassing – Telephone: 0049/8654/47310 – Fax: 0049/8654/4731 - 18

Prüfamt für Standsicherheit  
**LGA**  
Zweigstelle Landshut  
S-LA of

Result

$V_{Rd,c}$ [kN/m]	Concrete quality C20/25
Transverse force vertical - Case f data sheet Reverse bending to EC 2, Fig. 8	
Data sheet reverse bending figure 8f	
Good bond conditions according to DIN EN 1992-1-1 (for lower layer)	
$\sigma_{cd} = 0$	$b_w = 1.0m$ $a_2 \geq 5$ cm and smooth according to chapter 6.2.5 DIN EN 1992-1-1
Nevoga Plexus Type D	



d=	200 mm	240 mm	250 mm	270 mm	290 mm	320 mm	330 mm	350 mm	370 mm	400 mm
----	--------	--------	--------	--------	--------	--------	--------	--------	--------	--------

h=	350 mm	350 mm	350 mm	350 mm	350 mm	350 mm	350 mm	350 mm	350 mm	350 mm	
$\emptyset$ - Partition [mm]											
8 - 250	35.42	39.75	40.81	42.91	44.97	48.00	49.00	50.99	52.95	55.86	L <sub>s</sub> = 320 mm
8 - 200	35.42	39.75	40.81	42.91	44.97	48.00	49.00	50.99	52.95	55.86	
8 - 150	35.42	39.75	40.81	42.91	44.97	48.00	49.00	50.99	52.95	55.86	
8 - 100	35.42	39.75	40.81	42.91	44.97	48.00	49.00	50.99	52.95	55.86	

h=	430 mm	430 mm	430 mm	430 mm	430 mm	430 mm	430 mm	430 mm	430 mm	430 mm	
10 - 250	35.42	39.75	40.81	42.91	44.97	48.00	49.00	50.99	52.95	55.86	L <sub>s</sub> = 390 mm
10 - 200	35.42	39.75	40.81	42.91	44.97	48.00	49.00	50.99	52.95	55.86	
10 - 150	35.42	39.75	40.81	42.91	44.97	48.00	49.00	50.99	52.95	55.86	
10 - 100	35.42	39.75	40.81	42.91	44.97	48.00	49.00	50.99	52.95	55.86	

h=	510 mm	510 mm	510 mm	510 mm	510 mm	510 mm	510 mm	510 mm	510 mm	510 mm	
12 - 250	35.42	39.75	40.81	42.91	44.97	48.00	49.00	50.99	52.95	55.86	L <sub>s</sub> = 460 mm
12 - 200	35.42	39.75	40.81	42.91	44.97	48.00	49.00	50.99	52.95	55.86	
12 - 150	35.42	39.75	40.81	42.91	44.97	48.00	49.00	50.99	52.95	55.86	
12 - 100	35.42	39.75	40.81	42.91	44.97	48.00	49.00	50.99	52.95	55.86	

The verification of the pull-out lengths in construction section 2 must be carried out by the user!  
 The tensile force cover must be verified by the user in the pull-out area of the reverse bend connection!  
 According to DIN EN 1992-1-1, section 9.3.1.2, paragraph (1), at least half of the field reinforcement of solid slabs must be guided to the support and anchored there!

[www.nevoga.de](http://www.nevoga.de)  
 NEVOGA GmbH – Znaimer Str. 4 – D-83395 Freilassing – Telephone: 0049/8654/47310 – Fax: 0049/8654/4731 - 18

Prüfamt für Standsicherheit  
**LGA**  
 Zweigstelle Landshut  
 S-LA \_\_\_\_\_ of \_\_\_\_\_

Load tables Nevoga Plexus reinforcement connections

Absorbable shearing force transverse to the concrete joint (case f)      without transverse force reinforcement

Equation 6.2a  $V_{Rd,c} = c/0.5 * (C_{Rd,c} * k * (100 * \rho_i * f_{ck})^{1/3} = 0.12 * \sigma_{cp}) * b_x * d$

Equation 6.2b  $V_{Rd,c} = c/0.5 * (v_{min} + 0.12 * \sigma_{cp}) * b_w * d$

$$V_{Rd,c} = \max(6.2a; 6.2b)$$

With  $C_{Rd,c} = 0.15 / \gamma_c$

$$= 0.1$$

$$f_{ck} = 30 \text{ MN/m}^2$$

$$v_{min} = (0.0525 / \gamma_c) * k^{3/2} * f_{ck}^{1/2} \text{ for } d \leq 600 \text{ mm}$$

$$\alpha_{ct} = 0.85$$

$$\gamma_c = 1.5$$

$$f_{ctk,0.05} = b_w = 1.0 \text{ m}$$

Assumptions: Data sheet Reverse bending Case f

$$\sigma_{cp} = 0 \quad b_w = 1.0 \text{ m}$$

[www.Nevoga.de](http://www.Nevoga.de)





Calculation  $V_{Rd,c}$  [kN/m]

d=	200 mm	240 mm	250 mm	270 mm	290 mm	320 mm	330 mm	350 mm	370 mm	400 mm
k=	2	1.91287	1.89443	1.86066	1.83045	1.79057	1.7785	1.77593	1.75321	1.70711
$V_{Rd,c,min}$ [kN/m]	39.60	44.45	45.63	47.97	50.27	53.67	54.79	57.01	59.20	62.45

h=	350 mm	350 mm	350 mm	350 mm	350 mm	350 mm	350 mm	350 mm	350 mm	350 mm
∅ – Partition [mm]										
8 - 250	39.60	44.45	45.63	47.97	50.27	53.67	54.79	57.01	59.20	62.45
8 – 200	39.60	44.45	45.63	47.97	50.27	53.67	54.79	57.01	59.20	62.45
8 – 150	39.60	44.45	45.63	47.97	50.27	53.67	54.79	57.01	59.20	62.45
8 – 100	39.60	44.45	45.63	47.97	50.27	53.67	54.79	57.01	59.20	62.45

h=	430 mm	430 mm	430 mm	430 mm	430 mm	430 mm	430 mm	430 mm	430 mm	430 mm
10 - 250	39.60	44.45	45.63	47.97	50.27	53.67	54.79	57.01	59.20	62.45
10 – 200	39.60	44.45	45.63	47.97	50.27	53.67	54.79	57.01	59.20	62.45
10 – 150	39.60	44.45	45.63	47.97	50.27	53.67	54.79	57.01	59.20	62.45
10 – 100	39.60	44.45	45.63	47.97	50.27	53.67	54.79	57.01	59.20	62.45

h=	510 mm	510 mm	510 mm	510 mm	510 mm	510 mm	510 mm	510 mm	510 mm	510 mm
12 - 250	39.60	44.45	45.63	47.97	50.27	53.67	54.79	57.01	59.20	62.45
12 – 200	39.60	44.45	45.63	47.97	50.27	53.67	54.79	57.01	59.20	62.45
12 – 150	39.60	44.45	45.63	47.97	50.27	53.67	54.79	57.01	59.20	62.45
12 – 100	39.60	44.45	45.63	47.97	50.27	53.67	54.79	57.01	59.20	62.45

[www.nevoga.de](http://www.nevoga.de)  
NEVOGA GmbH – Znaimer Str. 4 – D-83395 Freilassing – Telephone: 0049/8654/47310 – Fax: 0049/8654/4731 - 18

Prüfamt für Standsicherheit  
**LGA**  
Zweigstelle Landshut  
S-LA \_\_\_\_\_ of

**Non-certified translation from the German original.**

Fritsche Ingenieure  
Ingenieurbüro für Bauwesen

Calculation rec.  $L_b$  [mm]

d=	200 mm	240 mm	250 mm	270 mm	290 mm	320 mm	330 mm	350 mm	370 mm	400 mm
----	--------	--------	--------	--------	--------	--------	--------	--------	--------	--------

h=	350 mm	350 mm	350 mm	350 mm	350 mm	350 mm	350 mm	350 mm	350 mm	350 mm
∅ – Partition [mm]										
8 - 250	114	128	131	138	144	154	157	164	170	179
8 – 200	91	102	105	110	116	123	126	131	136	144
8 – 150	80	80	80	83	87	93	94	98	102	109
8 – 100	80	80	80	80	80	80	80	80	80	80

h=	430 mm	430 mm	430 mm	430 mm	430 mm	430 mm	430 mm	430 mm	430 mm	430 mm
10 - 250	100	102	105	110	116	123	126	131	136	144
10 – 200	100	100	100	100	100	100	101	105	109	115
10 – 150	100	100	100	100	100	100	100	100	100	100
10 – 100	100	100	100	100	100	100	100	100	100	100

h=	510 mm	510 mm	510 mm	510 mm	510 mm	510 mm	510 mm	510 mm	510 mm	510 mm
12 - 250	120	120	120	120	120	120	120	120	120	120
12 – 200	120	120	120	120	120	120	120	120	120	120
12 – 150	120	120	120	120	120	120	120	120	120	120
12 – 100	120	120	120	120	120	120	120	120	120	120

[www.nevoga.de](http://www.nevoga.de)  
NEVOGA GmbH – Znaimer Str. 4 – D-83395 Freilassing – Telephone: 0049/8654/47310 – Fax: 0049/8654/4731 – 18

Prüfamt für Standsicherheit  
**LGA**  
Zweigstelle Landshut  
S-LA of

# Non-certified translation from the German original.

Fritsche Ingenieure

Ingenieurbüro für Bauwesen

Page 126

Result

$V_{Rd,c}$ [kN/m]	Concrete quality	C25/30
Transverse force vertical - Case e data sheet Reverse bending to EC 2, Fig. 8		
Data sheet reverse bending figure 8f		
Good bond conditions according to DIN EN 1992-1-1 (for lower layer)		
$\sigma_{cd} = 0$	$b_w = 1.0m$	$a_2 \geq 5 \text{ cm}$ and smooth according to chapter 6.2.5 DIN EN 1992-1-1
Nevoga Plexus Type D		



d=	200 mm	240 mm	250 mm	270 mm	290 mm	320 mm	330 mm	350 mm	370 mm	400 mm
----	--------	--------	--------	--------	--------	--------	--------	--------	--------	--------

h=	350 mm	350 mm	350 mm	350 mm	350 mm	350 mm	350 mm	350 mm	350 mm	350 mm	
Ø – Partition [mm]											
8 - 250	39.60	44.45	45.63	47.97	50.27	53.67	54.79	57.01	59.20	62.45	L <sub>s</sub> = 320 mm
8 - 200	39.60	44.45	45.63	47.97	50.27	53.67	54.79	57.01	59.20	62.45	
8 - 150	39.60	44.45	45.63	47.97	50.27	53.67	54.79	57.01	59.20	62.45	
8 - 100	39.60	44.45	45.63	47.97	50.27	53.67	54.79	57.01	59.20	62.45	

h=	430 mm	430 mm	430 mm	430 mm	430 mm	430 mm	430 mm	430 mm	430 mm	430 mm	
10 - 250	39.60	44.45	45.63	47.97	50.27	53.67	54.79	57.01	59.20	62.45	L <sub>s</sub> = 390 mm
10 - 200	39.60	44.45	45.63	47.97	50.27	53.67	54.79	57.01	59.20	62.45	
10 - 150	39.60	44.45	45.63	47.97	50.27	53.67	54.79	57.01	59.20	62.45	
10 - 100	39.60	44.45	45.63	47.97	50.27	53.67	54.79	57.01	59.20	62.45	

h=	510 mm	510 mm	510 mm	510 mm	510 mm	510 mm	510 mm	510 mm	510 mm	510 mm	
12 - 250	39.60	44.45	45.63	47.97	50.27	53.67	54.79	57.01	59.20	62.45	L <sub>s</sub> = 460 mm
12 - 200	39.60	44.45	45.63	47.97	50.27	53.67	54.79	57.01	59.20	62.45	
12 - 150	39.60	44.45	45.63	47.97	50.27	53.67	54.79	57.01	59.20	62.45	
12 - 100	39.60	44.45	45.63	47.97	50.27	53.67	54.79	57.01	59.20	62.45	

The verification of the pull-out lengths in construction section 2 must be carried out by the user!  
 The tensile force cover must be verified by the user in the pull-out area of the reverse bend connection!  
 According to DIN EN 1992-1-1, section 9.3.1.2, paragraph (1), at least half of the field reinforcement of solid slabs must be guided to the support and anchored there!

[www.nevoga.de](http://www.nevoga.de)

NEVOGA GmbH – Znaimer Str. 4 – D-83395 Freilassing – Telephone: 0049/8654/47310 – Fax: 0049/8654/4731 - 18

Prüfamt für Standsicherheit  
**LGA**  
 Zweigstelle Landshut

S-LA \_\_\_\_\_ of \_\_\_\_\_

## Non-certified translation from the German original.

Seite 127

Load tables Nevoga Plexus reinforcement connections

Absorbable shearing force transverse to the concrete joint (case f)      without transverse force reinforcement

$$\text{Equation 6.2a } V_{Rd,c} = c/0.5 * (C_{Rd,c} * k * (100 * \rho * f_{ck})^{1/3} = 0.12 * \sigma_{cp}) * b_x * d$$

$$\text{Equation 6.2b } V_{Rd,c} = c/0.5 * (v_{min} + 0.12 * \sigma_{cp}) * b_w * d$$

$$V_{Rd,c} = \max(6.2a; 6.2b)$$

With  $C_{Rd,c} = 0.15 / \gamma_c$

$$= 0.1$$

$$f_{ck} = 30 \quad \text{MN/m}^2$$

$$v_{min} = (0.0525 / \gamma_c) * k^{3/2} * f_{ck}^{1/2} \quad \text{for } d \leq 600 \text{ mm}$$

$$\alpha_{ct} = 0.85$$

$$\gamma_c = 1.5$$

$$f_{ctk,0.05} = b_w = 1.0 \text{ m}$$

Assumptions:    Data sheet Reverse bending Case f

$$\sigma_{cp} = 0 \quad b_w = 1.0 \text{ m}$$

[www.Nevoga.de](http://www.Nevoga.de)

Nevoga GmbH – Znaimer Str. 4 – D-83396 Freilassing – Telephone: 0049/8654/47310 – Fax: 0049/8654/4731- 18

**Non-certified translation from the German original.**

Fritsche Ingenieure  
Ingenieurbüro für Bauwesen

Calculation of reinforcement degree  $P_1$  [ $10^{-3}$ ]

d=	200 mm	240 mm	250 mm	270 mm	290 mm	320 mm	330 mm	350 mm	370 mm	400 mm
k=	2	1.91287	1.89443	1.86066	1.83045	1.79057	1.7785	1.75593	1.73521	1.70711

$\emptyset$ – Partition [mm]										
8 - 250	0.00101	0.00084	0,0008	0.00074	0.00069	0.00063	0.00061	0.00057	0.00054	0.0005
8 – 200	0.00126	0.00105	0.00101	0.00093	0.00087	0.00079	0.00076	0.00072	0.00068	0.0063
8 – 150	0.00168	0.0014	0.00134	0.00124	0.00116	0.00105	0.00102	0.00096	0.00091	0.00084
8 – 100	0.00251	0.00209	0.00201	0.00186	0.00173	0.00157	0.00152	0.00144	0.00136	0.00126

10 - 250	0.00157	0.00131	0.00126	0.00116	0.00108	0.00098	0.00095	0,0009	0.00085	0.00079
10 – 200	0.00196	0.00164	0.00157	0.00145	0.00135	0.00123	0.00119	0.00112	0.00106	0.00098
10 – 150	0.00262	0.00218	0.00209	0.00194	0.00181	0.00164	0.00159	0.0015	0.00142	0.00131
10 – 100	0.00393	0.00327	0.00314	0.00291	0.00271	0.00245	0.00238	0.00224	0.00212	0.00196

12 - 250	0.00226	0.00188	0.00181	0.00168	0.00156	0.00141	0.00137	0.00129	0.00122	0.00113
12 – 200	0.00283	0.00236	0.00226	0.00209	0.00195	0.00177	0.00171	0.00162	0.00153	0.00141
12 – 150	0.00377	0.00314	0.00302	0.00279	0.0026	0.00236	0.00228	0.00215	0.00204	0.00188
12 – 100	0.00565	0.00471	0.00452	0.00419	0.0039	0.00353	0.00343	0.00323	0.00306	0.00283

[www.nevoga.de](http://www.nevoga.de)  
NEVOGA GmbH – Znaimer Str. 4 – D-83395 Freilassing – Telephone: 0049/8654/47310 – Fax: 0049/8654/4731 – 18

Prüfamt für Standsicherheit  
**LGA**  
Zweigstelle Landshut  
S-LA of

Calculation  $V_{Rd,c}$  [kN/m]

d=	200 mm	240 mm	250 mm	270 mm	290 mm	320 mm	330 mm	350 mm	370 mm	400 mm
k=	2	1.91287	1.89443	1.86066	1.83045	1.79057	1.7785	1.77593	1.75321	1.70711
$V_{Rd,c,min}$ [kN/m]	43.38	48.69	49.99	52.55	55.07	58.79	60.02	62.45	64.85	68.41

h=	350 mm	350 mm	350 mm	350 mm	350 mm	350 mm	350 mm	350 mm	350 mm	350 mm
∅ – Partition [mm]										
8 - 250	43.38	48.69	49.99	52.55	55.07	58.79	60.02	62.45	64.85	68.41
8 – 200	43.38	48.69	49.99	52.55	55.07	58.79	60.02	62.45	64.85	68.41
8 – 150	43.38	48.69	49.99	52.55	55.07	58.79	60.02	62.45	64.85	68.41
8 – 100	43.38	48.69	49.99	52.55	55.07	58.79	60.02	62.45	64.85	68.41

h=	430 mm	430 mm	430 mm	430 mm	430 mm	430 mm	430 mm	430 mm	430 mm	430 mm
10 - 250	43.38	48.69	49.99	52.55	55.07	58.79	60.02	62.45	64.85	68.41
10 – 200	43.38	48.69	49.99	52.55	55.07	58.79	60.02	62.45	64.85	68.41
10 – 150	43.38	48.69	49.99	52.55	55.07	58.79	60.02	62.45	64.85	68.41
10 – 100	43.38	48.69	49.99	52.55	55.07	58.79	60.02	62.45	64.85	68.41

h=	510 mm	510 mm	510 mm	510 mm	510 mm	510 mm	510 mm	510 mm	510 mm	510 mm
12 - 250	43.38	48.69	49.99	52.55	55.07	58.79	60.02	62.45	64.85	68.41
12 – 200	43.38	48.69	49.99	52.55	55.07	58.79	60.02	62.45	64.85	68.41
12 – 150	43.38	48.69	49.99	52.55	55.07	58.79	60.02	62.45	64.85	68.41
12 – 100	43.38	48.69	49.99	52.55	55.07	58.79	60.02	62.45	64.85	68.41

[www.nevoga.de](http://www.nevoga.de)  
NEVOGA GmbH – Znaimer Str. 4 – D-83395 Freilassing – Telephone: 0049/8654/47310 – Fax: 0049/8654/4731 - 18

Prüfamt für Standsicherheit  
**LGA**  
Zweigstelle Landshut  
S-LA of

Calculation rec.  $L_b$  [mm]

d=	200 mm	240 mm	250 mm	270 mm	290 mm	320 mm	330 mm	350 mm	370 mm	400 mm
----	--------	--------	--------	--------	--------	--------	--------	--------	--------	--------

h=	350 mm	350 mm	350 mm	350 mm	350 mm	350 mm	350 mm	350 mm	350 mm	350 mm
----	--------	--------	--------	--------	--------	--------	--------	--------	--------	--------

Ø – Partition [mm]										
8 - 250	110	124	127	134	140	150	153	159	165	174
8 - 200	88	99	102	107	112	120	122	127	132	139
8 - 150	80	80	80	80	84	90	92	95	99	104
8 - 100	80	80	80	80	80	80	80	80	80	80

h=	430 mm	430 mm	430 mm	430 mm	430 mm	430 mm	430 mm	430 mm	430 mm	430 mm
10 - 250	100	100	102	107	112	120	122	127	132	139
10 - 200	100	100	100	100	100	100	100	102	106	111
10 - 150	100	100	100	100	100	100	100	100	100	100
10 - 100	100	100	100	100	100	100	100	100	100	100

h=	510 mm	510 mm	510 mm	510 mm	510 mm	510 mm	510 mm	510 mm	510 mm	510 mm
12 - 250	120	120	120	120	120	120	120	120	120	120
12 - 200	120	120	120	120	120	120	120	120	120	120
12 - 150	120	120	120	120	120	120	120	120	120	120
12 - 100	120	120	120	120	120	120	120	120	120	120

[www.nevoga.de](http://www.nevoga.de)  
NEVOGA GmbH – Znaimer Str. 4 – D-83395 Freilassing – Telephone: 0049/8654/47310 – Fax: 0049/8654/4731 - 18

Prüfamt für Standsicherheit  
**LGA**  
Zweigstelle Landshut  
S-LA of



Result

$V_{Rd,c}$	[kN/m]	Concrete quality	C30/37
Transverse force vertical - Case f data sheet Reverse bending to EC 2, Fig. 8			
Data sheet reverse bending figure 8f			
Good bond conditions according to DIN EN 1992-1-1 (for lower layer)			
$\sigma_{cd}$	= 0	$b_w = 1.0m$	$a_2 \geq 5$ cm and smooth according to chapter 6.2.5 DIN EN 1992-1-1
Nevoga Plexus Type D			



d=	200 mm	240 mm	250 mm	270 mm	290 mm	320 mm	330 mm	350 mm	370 mm	400 mm
----	--------	--------	--------	--------	--------	--------	--------	--------	--------	--------

h=	350 mm	350 mm	350 mm	350 mm	350 mm	350 mm	350 mm	350 mm	350 mm	350 mm	
$\emptyset$ - Partition [mm]											
8 - 250	43.38	48.69	49.99	52.55	55.07	58.79	60.02	62.45	64.85	68.41	L <sub>s</sub> = 320 mm
8 - 200	43.38	48.69	49.99	52.55	55.07	58.79	60.02	62.45	64.85	68.41	
8 - 150	43.38	48.69	49.99	52.55	55.07	58.79	60.02	62.45	64.85	68.41	
8 - 100	43.38	48.69	49.99	52.55	55.07	58.79	60.02	62.45	64.85	68.41	

h=	430 mm	430 mm	430 mm	430 mm	430 mm	430 mm	430 mm	430 mm	430 mm	430 mm	
10 - 250	43.38	48.69	49.99	52.55	55.07	58.79	60.02	62.45	64.85	68.41	L <sub>s</sub> = 390 mm
10 - 200	43.38	48.69	49.99	52.55	55.07	58.79	60.02	62.45	64.85	68.41	
10 - 150	43.38	48.69	49.99	52.55	55.07	58.79	60.02	62.45	64.85	68.41	
10 - 100	43.38	48.69	49.99	52.55	55.07	58.79	60.02	62.45	64.85	68.41	

h=	510 mm	510 mm	510 mm	510 mm	510 mm	510 mm	510 mm	510 mm	510 mm	510 mm	
12 - 250	43.38	48.69	49.99	52.55	55.07	58.79	60.02	62.45	64.85	68.41	L <sub>s</sub> = 460 mm
12 - 200	43.38	48.69	49.99	52.55	55.07	58.79	60.02	62.45	64.85	68.41	
12 - 150	43.38	48.69	49.99	52.55	55.07	58.79	60.02	62.45	64.85	68.41	
12 - 100	43.38	48.69	49.99	52.55	55.07	58.79	60.02	62.45	64.85	68.41	

The verification of the pull-out lengths in construction section 2 must be carried out by the user!  
 The tensile force cover must be verified by the user in the pull-out area of the reverse bend connection!  
 According to DIN EN 1992-1-1, section 9.3.1.2, paragraph (1), at least half of the field reinforcement of solid slabs must be guided to the support and anchored there!

[www.nevoga.de](http://www.nevoga.de)

NEVOGA GmbH – Znaimer Str. 4 – D-83395 Freilassing – Telephone: 0049/8654/47310 – Fax: 0049/8654/4731 - 18

Prüfamt für Standsicherheit  
**LGA**  
 Zweigstelle Landshut

S-LA \_\_\_\_\_ of \_\_\_\_\_

**Non-certified translation from the German original.**

Fritsche Ingenieure    Ingenieurbüro für Bauwesen  
Deggendorf

**Static calculation  
Part 2**

Load tables for Nevoga Plexus reinforcement connections

Client:        NEVOGA GmbH  
                  Znaimerstr. 4  
                  83395 Freilassing

Operator:    Fritsche Ingenieure    Ingenieurbüro für Bauwesen  
                  West., Stadtgraben 30 b – 94469 Deggendorf

Deggendorf, 19/08/2013

Dipl. -Ing. Stefan Hentschinski

Tester:        Valid until 31/03/2019  
                  Type test  
                  Tested with regard to stability  
                  See test report SLA 130164 of 20/03/2014  
                  LGA Prüfamnt für Standsicherheit  
                  der Zweigstelle Landshut

Landshut,    30/03/2014  
The processor

Manager

In the following, the various types for rebend connections are assigned to the Plexus types in accordance with the DBV data sheet "Rebending of reinforcing steel and requirements for protective boxes".

The shearing forces that can be absorbed at the concreting joint are calculated in relation to these types and shown in the following table.

A test report for shearing tests in longitudinal and transverse direction was available. In the following, the shearing force that can be absorbed for types A, B, D, DD, I and M is calculated.

These are assigned to the standard cases of the DBV data sheet Fig. 8.

DBV data sheet Figure 8 a

NevogaPlexus

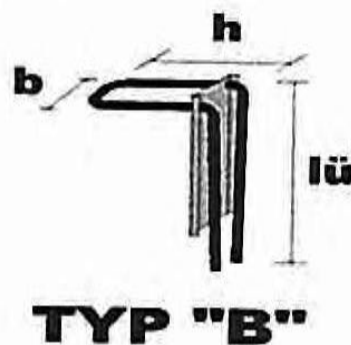
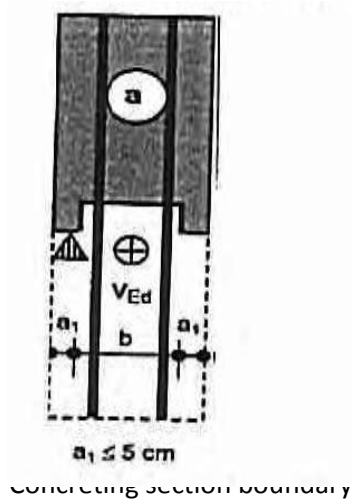

Load: Shearing force parallel

DBV data sheet Figure 8 b

Nevoga Plexus

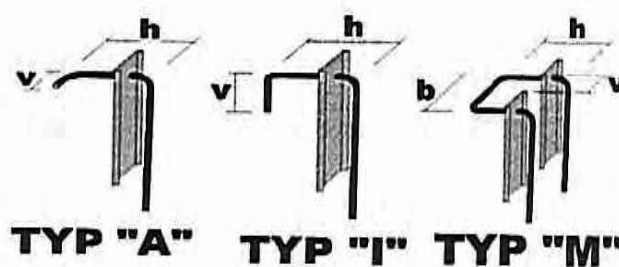
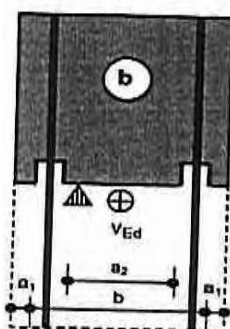

Load: Shearing force parallel

Valid until 31/03/2019

Type test

Tested with regard to stability  
See test report SLA 130164 of

20/03/2014

LGA Prüfamts für Standsicherheit  
der Zweigstelle Landshut

DBV data sheet Figure 8c

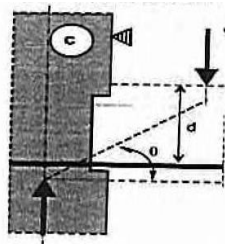

Nevoga Plexus

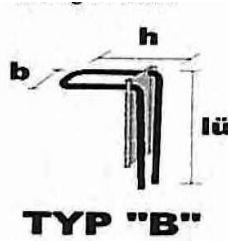

Connection wall-ceiling

Load: Shearing force vertical

DBV data sheet Figure 8d

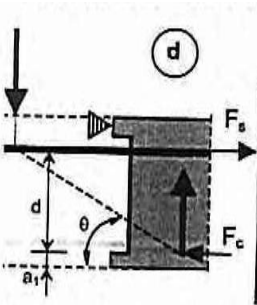

Nevoga Plexus

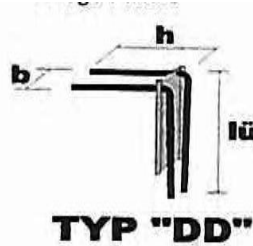

Connection wall-ceiling

Load: Shearing force vertical

Valid until 31/03/2019

Type test

Tested with regard to stability

See test report SLA 130164 of 20/03/2014

LGA Prüfamt für Standsicherheit

der Zweigstelle Landshut

Landshut 30/03/2014

DBV data sheet Figure 8e

Nevoga Plexus

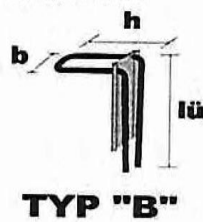
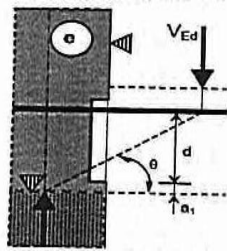

Connection wall-ceiling

Load: Shearing force vertical

DBV data sheet Figure 8f

NevogaPlexus

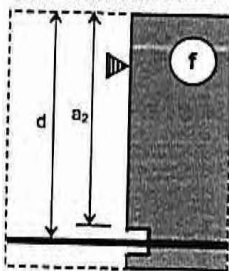

Connection wall-ceiling

Load: Shearing force vertical

Valid until 31/03/2019

Type test

Tested with regard to stability

See test report SLA 130164 of 20/03/2014

LGA Prüfamt für Standsicherheit

der Zweigstelle Landshut

Landshut, 30/03/2014

Evaluation

Assumptions: Data sheet Reverse bending Fig. 8 a      direct mounting in CS 1

$\sigma_{cd} + () \text{ MN/m}^2$ $b_w = 1.0 \text{ m}$	$A_1 < 50 \text{ mm}$ $v = 0.20$
Concrete quality 20 / 25	$C = 0.20$ $\mu = 0.60$
$V_{Rd,i} [\text{kN/m}]$	
Nevoga Plexus Type B	



Box width B	85 mm	115 mm	145 mm	175 mm	205 mm	225 mm	mm
Anchorage	h = 15 cm	h = 15 cm	h = 15 cm	h = 15 cm	h = 15 cm	h = 15 cm	Pull-out
Ø 8-25	96.33	104.06	109.06	114.06	119.06	122.40	L <sub>s</sub> = 320 mm
Ø 8-20	96.33	125.39	130.39	135.39	140.39	143.73	
Ø 8-15	96.33	130.33	164.33	170.66	175.66	178.99	
Ø 8-10	96.33	130.33	164.33	198.33	232.33	249.74	

Box width B	85 mm	115 mm	145 mm	175 mm	205 mm	225 mm	mm
Anchorage	h = 15 cm	h = 15 cm	h = 15 cm	h = 15 cm	h = 15 cm	h = 15 cm	Pull-out
Ø 10-25	96.33	118.07	123.07	128.07	133.07	136.41	L <sub>s</sub> = 390 mm
Ø 10-20	96.33	130.33	147.80	152.80	157.80	161.13	
Ø 10-15	96.33	130.33	164.33	194.06	199.06	202.40	
Ø 10-10	96.33	130.33	164.33	198.33	232.33	255.00	

Box width B	85 mm	115 mm	145 mm	175 mm	205 mm	225 mm	mm
Anchorage	h = 17 cm	h = 17 cm	h = 17 cm	h = 17 cm	h = 17 cm	h = 17 cm	Pull-out
Ø 12-25	Production technically not possible!	130.33	155.90	160.99	165.90	169.23	L <sub>s</sub> = 460 mm
Ø 12-20		130.33	164.33	193.80	198.80	202.13	
Ø 12-15		130.33	164.33	198.33	232.33	255.00	
Ø 12-10		130.33	164.33	198.33	232.33	255.00	

The verification of the pull-out lengths in construction section 2 must be carried out by the user!

The boundary conditions, whether direct or indirect mounting of construction section 1 was given, must be checked by the user!

Valid until 31/03/2019

Type test

Tested with regard to stability  
See test report SLA 130164 of 20/03/2014

LGA Prüfamt für Standsicherheit

der Zweigstelle Landshut

Landshut, 30/03/2014

Evaluation

Assumptions: Data sheet Reverse bending Fig. 8 a indirect mounting in CS 1

$\sigma_{cd} + () \text{ MN/m}^2$ $b_w = 1.0 \text{ m}$	$A_1 < 50 \text{ mm}$ $v = 0.20$
Concrete quality 20 / 25	$C = 0.20$ $\mu = 0.60$
$V_{Rd,i} [\text{kN/m}]$	
Nevoga Plexus Type B	

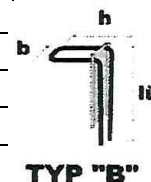

Box width B	85 mm	115 mm	145 mm	175 mm	205 mm	225 mm	mm
Anchorage	h = 15 cm	h = 15 cm	h = 15 cm	h = 15 cm	h = 15 cm	h = 15 cm	Pull-out
Ø 8-25	70.76	75.76	80.76	85.76	90.76	94.10	L <sub>s</sub> = 320 mm
Ø 8-20	84.98	89.98	94.98	99.98	104.98	108.32	
Ø 8-15	96.33	113.50	118.50	123.50	128.50	131.83	
Ø 8-10	96.33	130.33	164.33	170.66	175.66	178.99	

Box width B	85 mm	115 mm	145 mm	175 mm	205 mm	225 mm	mm
Anchorage	h = 15 cm	h = 15 cm	h = 15 cm	h = 15 cm	h = 15 cm	h = 15 cm	Pull-out
Ø 10-25	80.10	85.10	90.10	95.10	100.10	103.44	L <sub>s</sub> = 390 mm
Ø 10-20	96.33	101.59	106.59	111.59	116.59	119.92	
Ø 10-15	96.33	129.10	134.10	139.10	144.10	147.43	
Ø 10-10	96.33	130.33	164.33	194.12	199.12	202.45	

Box width B	85 mm	115 mm	145 mm	175 mm	205 mm	225 mm	mm
Anchorage	h = 17 cm	h = 17 cm	h = 17 cm	h = 17 cm	h = 17 cm	h = 17 cm	Pull-out
Ø 12-25	Production technically not possible	106.99	111.99	116.99	121.99	125.32	L <sub>s</sub> = 460 mm
Ø 12-20		128.92	133.92	138.92	143.92	147.25	
Ø 12-15		130.33	164.33	175.51	180.51	183.84	
Ø 12-10		130.33	164.33	198.33	232.33	255.00	

The verification of the pull-out lengths in construction section 2 must be carried out by the user!

Valid until 31/03/2019

Type test

Tested with regard to stability  
See test report SLA 130164 of 20/03/2014

LGA Prüfamt für Standsicherheit

der Zweigstelle Landshut

Landshut, 30/03/2014

**Non-certified translation from the German original.**

Evaluation

Assumptions: Data sheet Reverse bending Fig. 8 a indirect mounting in CS 1

$\sigma_{cd} + () \text{ MN/m}^2$ $b_w = 1.0 \text{ m}$	$A_1 < 50 \text{ mm}$ $v = 0.20$
Concrete quality 25 / 30	$C = 0.20$ $\mu = 0.60$
$V_{Rd,i} [\text{kN/m}]$	
Nevoga Plexus Type B	

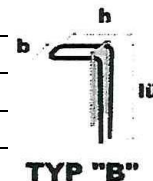

Box width B	85 mm	115 mm	145 mm	175 mm	205 mm	225 mm	mm
Anchorage	h = 15 cm	h = 15 cm	h = 15 cm	h = 15 cm	h = 15 cm	h = 15 cm	Pull-out
Ø 8-25	115.44	121.44	127.44	133.44	139.44	143.44	L <sub>s</sub> = 320 mm
Ø 8-20	120.42	146.17	152.17	158.17	164.17	168.17	
Ø 8-15	120.42	162.92	193.06	199.06	205.06	209.06	
Ø 8-10	120.42	162.92	205.42	247.92	287.09	291.09	

Box width B	85 mm	115 mm	145 mm	175 mm	205 mm	225 mm	mm
Anchorage	h = 15 cm	h = 15 cm	h = 15 cm	h = 15 cm	h = 15 cm	h = 15 cm	Pull-out
Ø 10-25	120.42	137.68	143.68	149.68	155.68	159.68	L <sub>s</sub> = 390 mm
Ø 10-20	120.42	162.92	172.35	178.35	184.25	188.35	
Ø 10-15	120.42	162.92	205.42	226.20	232.30	236.20	
Ø 10-10	120.42	162.92	205.42	247.92	290.42	318.75	

Box width B	85 mm	115 mm	145 mm	175 mm	205 mm	225 mm	mm
Anchorage	h = 17 cm	h = 17 cm	h = 17 cm	h = 17 cm	h = 17 cm	h = 17 cm	Pull-out
Ø 12-25	Production technically not possible!	162.92	181.74	187.74	193.74	197.74	L <sub>s</sub> = 460 mm
Ø 12-20		162.92	205.42	225.89	231.89	235.89	
Ø 12-15		162.92	205.42	247.92	290.42	299.52	
Ø 12-10		162.92	205.42	247.92	290.42	318.75	

The verification of the pull-out lengths in construction section 2 must be carried out by the user!

The boundary conditions, whether direct or indirect mounting of construction section 1 was given, must be checked by the user!

Valid until 31/03/2019

Type test

Tested with regard to stability

See test report SLA 130164 of 20/03/2014

LGA Prüfamf für Standsicherheit

der Zweigstelle Landshut

Landshut, 30/03/2014



Evaluation

Assumptions: Data sheet Reverse bending Fig. 8 a indirect mounting in CS 1

$\sigma_{cd} + () \text{ MN/m}^2$ $b_w = 1.0 \text{ m}$	$A_1 < 50 \text{ mm}$ $v = 0.20$
Concrete quality 25 / 30	$C = 0.20$ $\mu = 0.60$
$V_{Rd,i} [\text{kN/m}]$	
Nevoga Plexus Type B	

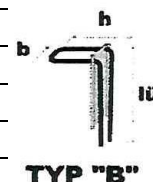

Box width B	85 mm	115 mm	145 mm	175 mm	205 mm	225 mm	mm
Anchorage	h = 15 cm	h = 15 cm	h = 15 cm	h = 15 cm	h = 15 cm	h = 15 cm	Pull-out
Ø 8-25	82.62	88.62	94.62	100.62	106.62	110.62	L <sub>s</sub> = 320 mm
Ø 8-20	99.11	105.11	111.11	117.11	123.11	127.11	
Ø 8-15	120.42	132.37	138.37	144.37	150.37	154.37	
Ø 8-10	120.42	162.92	193.06	199.06	205.06	209.06	

Box width B	85 mm	115 mm	145 mm	175 mm	205 mm	225 mm	mm
Anchorage	h = 15 cm	h = 15 cm	h = 15 cm	h = 15 cm	h = 15 cm	h = 15 cm	Pull-out
Ø 10-25	93.45	99.45	105.45	111.45	117.45	121.45	L <sub>s</sub> = 390 mm
Ø 10-20	112.57	118.57	124.57	130.57	136.57	140.57	
Ø 10-15	120.42	150.46	156.46	162.46	168.46	172.46	
Ø 10-10	120.42	162.92	205.42	226.26	232.26	236.26	

Box width B	85 mm	115 mm	145 mm	175 mm	205 mm	225 mm	mm
Anchorage	h = 17 cm	h = 17 cm	h = 17 cm	h = 17 cm	h = 17 cm	h = 17 cm	Pull-out
Ø 12-25	Production technically not possible!	124.83	130.83	136.83	142.83	146.83	L <sub>s</sub> = 460 mm
Ø 12-20		150.26	156.26	162.26	166.26	172.26	
Ø 12-15		162.92	198.68	204.68	210.68	214.68	
Ø 12-10		162.92	205.42	247.92	290.42	299.52	

The verification of the pull-out lengths in construction section 2 must be carried out by the user!

Valid until 31/03/2019

Type test

Tested with regard to stability  
See test report SLA 130164 of 20/03/2014

LGA Prüfamt für Standsicherheit

der Zweigstelle Landshut

Landshut, 30/03/2014

Evaluation

Assumptions: Data sheet Reverse bending Fig. 8 a indirect mounting in CS 1

$\sigma_{cd} + () \text{ MN/m}^2$ $b_w = 1.0 \text{ m}$	$A_1 < 50 \text{ mm}$ $v = 0.20$
Concrete quality 30 / 37	$C = 0.20$ $\mu = 0.60$
$V_{Rd,i} [\text{kN/m}]$	
Nevoga Plexus Type B	

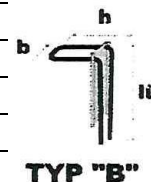

Box width B	85 mm	115 mm	145 mm	175 mm	205 mm	225 mm	mm
Anchorage	h = 15 cm	h = 15 cm	h = 15 cm	h = 15 cm	h = 15 cm	h = 15 cm	Pull-out
Ø 8-25	130.13	136.80	143.47	150.13	156.80	161.24	L <sub>s</sub> = 320 mm
Ø 8-20	144.50	164.65	171.32	177.99	184.65	189.10	
Ø 8-15	144.50	195.50	217.69	224.35	231.02	235.46	
Ø 8-10	144.50	195.50	246.50	297.50	323.75	328.20	

Box width B	85 mm	115 mm	145 mm	175 mm	205 mm	225 mm	mm
Anchorage	h = 15 cm	h = 15 cm	h = 15 cm	h = 15 cm	h = 15 cm	h = 15 cm	Pull-out
Ø 10-25	144.50	155.16	161.82	168.49	175.16	179.60	L <sub>s</sub> = 390 mm
Ø 10-20	144.50	187.56	194.22	200.89	207.56	212.00	
Ø 10-15	144.50	195.50	246.50	254.96	261.63	266.07	
Ø 10-10	144.50	195.50	246.50	297.50	348.50	374.21	

Box width B	85 mm	115 mm	145 mm	175 mm	205 mm	225 mm	mm
Anchorage	h = 17 cm	h = 17 cm	h = 17 cm	h = 17 cm	h = 17 cm	h = 17 cm	Pull-out
Ø 12-25	144.50	195.50	204.84	211.51	218.17	222.62	L <sub>s</sub> = 460 mm
Ø 12-20	144.50	195.50	246.50	254.61	261.28	265.73	
Ø 12-15	144.50	195.50	246.50	297.50	333.19	337.63	
Ø 12-10	144.50	195.50	246.50	297.50	348.50	382.50	

The verification of the pull-out lengths in construction section 2 must be carried out by the user!

The boundary conditions, whether direct or indirect mounting of construction section 1 was given, must be checked by the user!

Valid until 31/03/2019

Type test

Tested with regard to stability  
See test report SLA 130164 of 20/03/2014

LGA Prüfamt für Standsicherheit  
der Zweigstelle Landshut

Landshut, 30/03/2014

**Non-certified translation from the German original.**

Evaluation

Assumptions: Data sheet Reverse bending Fig. 8 a indirect mounting in CS 1

$\sigma_{cd} + () \text{ MN/m}^2$	$b_w = 1.0 \text{ m}$	$A_1 < 50 \text{ mm}$	$v = 0.20$
Concrete quality	30 / 37	$C = 0.20$	$\mu = 0.60$
$V_{Rd,i} \text{ [kN/m]}$			
Nevoga Plexus Type B			

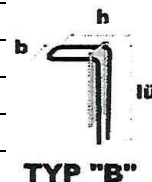

Box width B	85 mm	115 mm	145 mm	175 mm	205 mm	225 mm	mm
Anchorage	h = 15 cm	h = 15 cm	h = 15 cm	h = 15 cm	h = 15 cm	h = 15 cm	Pull-out
Ø 8-25	93.05	99.72	106.39	113.05	119.72	124.16	L <sub>s</sub> = 320 mm
Ø 8-20	111.68	118.35	125.02	131.68	138.35	142.80	
Ø 8-15	142.49	149.16	155.83	162.49	69.16	173.60	
Ø 8-10	144.50	195.50	217.63	224.30	230.96	235.41	

Box width B	85 mm	115 mm	145 mm	175 mm	205 mm	225 mm	mm
Anchorage	h = 15 cm	h = 15 cm	h = 15 cm	h = 15 cm	h = 15 cm	h = 15 cm	Pull-out
Ø 10-25	105.29	111.96	118.62	125.29	131.96	136.40	L <sub>s</sub> = 390 mm
Ø 10-20	126.89	133.56	140.22	146.89	153.56	158.00	
Ø 10-15	144.50	169.60	176.27	182.94	189.60	194.05	
Ø 10-10	144.50	195.50	246.50	255.03	261.70	266.14	

Box width B	85 mm	115 mm	145 mm	175 mm	205 mm	225 mm	mm
Anchorage	h = 17 cm	h = 17 cm	h = 17 cm	h = 17 cm	h = 17 cm	h = 17 cm	Pull-out
Ø 12-25	Production technically not possible!	140.63	147.30	153.97	160.63	165.08	L <sub>s</sub> = 460 mm
Ø 12-20		169.37	176.04	182.71	189.37	193.82	
Ø 12-15		195.50	223.98	230.64	237.31	241.76	
Ø 12-10		195.50	246.50	297.50	333.19	337.63	

The verification of the pull-out lengths in construction section 2 must be carried out by the user!

Valid until 31/03/2019

Type test

Tested with regard to stability  
See test report SLA 130164 of 20/03/2014

LGA Prüfamt für Standsicherheit  
der Zweigstelle Landshut

Landshut, 30/03/2014

**Non-certified translation from the German original.**

Fritsche Ingenieure

Ingenieurbüro für Bauwesen

Page 7

Evaluation

Assumptions: Data sheet reverse bending figure 8 b

B = Design width of wall = Wall thickness - 2a <sub>1</sub>		
a <sub>2</sub> ≥ 50 mm with surface finish smooth according to DIN EN 1992-1-1 6.2.5		
σ <sub>cd</sub> + ( ) MN/m <sup>2</sup>	A <sub>1</sub> < 50 mm	v = 0.20
Concrete quality 20 / 25	C= 0.20	μ = 0.60
V <sub>Rd,i</sub> [kN/m]		
Nevoga Plexus Type A, I, M		



B	200 mm	250 mm	275 mm	300 mm	325 mm	350 mm	375 mm	400 mm	mm
Anchorage	h = 15 cm	h = 15 cm	h = 15 cm	h = 15 cm	h = 15 cm	h = 15 cm	h = 15 cm	h = 15 cm	Pull-out
∅ 8-25	89.93	98.26	102.43	106.60	110.76	114.93	119.10	123.26	L <sub>s</sub> = 320 mm
∅ 8-20	104.15	112.48	116.65	120.82	124.98	129.15	133.32	137.48	
∅ 8-15	127.66	136.00	140.16	144.33	148.50	152.66	156.83	161.00	
∅ 8-10	174.83	183.16	187.33	191.49	195.66	199.83	203.99	208.16	



B	200 mm	250 mm	275 mm	300 mm	325 mm	350 mm	375 mm	400 mm	mm
Anchorage	h = 15 cm	h = 15 cm	h = 15 cm	h = 15 cm	h = 15 cm	h = 15 cm	h = 15 cm	h = 15 cm	Pull-out
∅ 8-25	99.27	107.60	111.77	115.94	120.10	124.27	128.44	132.60	L <sub>s</sub> = 390 mm
∅ 8-20	115.76	124.09	128.26	132.42	135.59	140.76	144.92	149.09	
∅ 8-15	143.26	151.60	155.76	159.93	164.10	168.26	172.43	176.60	
∅ 8-10	198.28	206.62	210.78	214.95	219.12	233.28	227.45	231.62	

B	200 mm	250 mm	275 mm	300 mm	325 mm	350 mm	375 mm	400 mm	mm
Anchorage	h = 17 cm	h = 17 cm	h = 17 cm	h = 17 cm	h = 17 cm	h = 17 cm	h = 17 cm	h = 17 cm	Pull-out
∅ 8-25	121.16	129.49	133.66	137.82	141.99	146.16	150.32	154.49	L <sub>s</sub> = 460 mm
∅ 8-20	143.09	151.42	155.59	159.75	163.92	168.09	172.25	176.42	
∅ 8-15	179.67	188.01	192.17	196.34	200.51	204.67	208.84	213.01	
∅ 8-10	226.67	261.18	265.34	269.51	273.68	277.84	282.01	286.18	

The verification of the pull-out lengths in construction section 2 must be carried out by the user!

Valid until 31/03/2019

Type test

Tested with regard to stability  
See test report SLA 130164 of  
20/03/2014

LGA Prüfamt für Standsicherheit  
der Zweigstelle Landshut

**Non-certified translation from the German original.**

Evaluation

Assumptions: Data sheet reverse bending figure 8 b

B = Design width of wall = Wall thickness - 2a <sub>1</sub>		
a <sub>2</sub> ≥ 50 mm with surface finish smooth according to DIN EN 1992-1-1 6.2.5		
σ <sub>cd</sub> + ( ) MN/m <sup>2</sup>	A <sub>1</sub> < 50 mm	v = 0.20
Concrete quality 25 / 30	C= 0.20	μ = 0.60
V <sub>Rd,i</sub> [kN/m]		
Nevoga Plexus Type A, I, M		



B	200 mm	250 mm	275 mm	300 mm	325 mm	350 mm	375 mm	400 mm	mm
Anchorage	h = 15 cm	h = 15 cm	h = 15 cm	h = 15 cm	h = 15 cm	h = 15 cm	h = 15 cm	h = 15 cm	Pull-out
∅ 8-25	105.62	115.62	120.62	125.62	130.62	135.62	140.62	145.62	L <sub>s</sub> = 320 mm
∅ 8-20	122.11	132.11	137.11	142.11	147.11	152.11	157.11	162.11	
∅ 8-15	149.37	159.37	164.37	169.37	174.37	179.37	184.37	189.37	
∅ 8-10	204.06	214.06	219.06	224.06	229.06	234.06	239.06	244.06	



B	200 mm	250 mm	275 mm	300 mm	325 mm	350 mm	375 mm	400 mm	mm
Anchorage	h = 15 cm	h = 15 cm	h = 15 cm	h = 15 cm	h = 15 cm	h = 15 cm	h = 15 cm	h = 15 cm	Pull-out
∅ 8-25	116.45	126.45	131.45	138.45	141.45	146.45	151.45	156.45	L <sub>s</sub> = 390 mm
∅ 8-20	135.57	145.57	150.57	155.57	160.57	165.57	170.57	175.57	
∅ 8-15	167.46	177.46	182.46	187.46	192.46	197.46	202.46	207.46	
∅ 8-10	231.26	241.26	246.26	251.26	256.26	261.26	266.26	271.26	



B	200 mm	250 mm	275 mm	300 mm	325 mm	350 mm	375 mm	400 mm	mm
Anchorage	h = 17 cm	h = 17 cm	h = 17 cm	h = 17 cm	h = 17 cm	h = 17 cm	h = 17 cm	h = 17 cm	Pull-out
∅ 8-25	141.83	151.83	156.83	161.83	166.83	171.83	176.83	181.83	L <sub>s</sub> = 460 mm
∅ 8-20	167.26	177.26	182.26	187.26	192.26	197.26	202.26	207.26	
∅ 8-15	209.68	219.68	224.68	229.68	234.68	339.68	244.68	249.68	
∅ 8-10	283.33	304.52	309.52	314.52	319.52	324.52	329.52	334.52	

The verification of the pull-out lengths in construction section 2 must be carried out by the user!

Valid until 31/03/2019

Type test

Tested with regard to stability

See test report SLA 130164 of 20/03/2014

LGA Prüfamt für Standsicherheit

der Zweigstelle Landshut

Landshut, 30/03/2014

**Non-certified translation from the German original.**

Fritsche Ingenieure  
Ingenieurbüro für Bauwesen

Evaluation

Assumptions: Data sheet reverse bending figure 8 b

B = Design width of wall = Wall thickness - 2a <sub>1</sub>	
a <sub>2</sub> ≥ 50 mm with surface finish smooth according to DIN EN 1992-1-1 6.2.5	
σ <sub>cd</sub> + ( ) MN/m <sup>2</sup>	A <sub>1</sub> < 50 mm v = 0.20
Concrete quality 30 / 37	C = 0.20 μ = 0.60
V <sub>Rdi</sub> [kN/m] V <sub>r,n,i</sub>	
Nevoga Plexus Type A, I, M	



B	200 mm	250 mm	275 mm	300 mm	325 mm	350 mm	375 mm	400 mm	mm
Anchorage	h = 15 cm	h = 15 cm	h = 15 cm	h = 15 cm	h = 15 cm	h = 15 cm	h = 15 cm	h = 15 cm	Pull-out
∅ 8-25	118.61	129.72	135.27	140.83	146.39	151.94	157.50	163.05	L <sub>s</sub> = 320 mm
∅ 8-20	137.24	148.35	153.91	159.46	165.02	170.57	176.13	181.68	
∅ 8-15	168.05	179.15	184.72	190.27	195.83	201.38	206.94	212.49	
∅ 8-10	229.85	240.96	246.52	252.07	257.63	263.18	268.74	274.30	



B	200 mm	250 mm	275 mm	300 mm	325 mm	350 mm	375 mm	400 mm	mm
Anchorage	h = 15 cm	h = 15 cm	h = 15 cm	h = 15 cm	h = 15 cm	h = 15 cm	h = 15 cm	h = 15 cm	Pull-out
∅ 8-25	130.85	141.96	147.51	153.07	158.62	164.18	169.73	175.29	L <sub>s</sub> = 390 mm
∅ 8-20	152.45	163.56	169.11	174.67	180.22	185.78	191.33	196.89	
∅ 8-15	188.49	199.60	205.16	210.71	216.27	221.83	227.38	232.94	
∅ 8-10	260.59	271.70	277.25	282.81	288.36	293.92	299.47	305.03	



B	200 mm	250 mm	275 mm	300 mm	325 mm	350 mm	375 mm	400 mm	mm
Anchorage	h = 17 cm	h = 17 cm	h = 17 cm	h = 17 cm	h = 17 cm	h = 17 cm	h = 17 cm	h = 17 cm	Pull-out
∅ 8-25	159.52	170.63	176.19	181.75	187.30	192.86	198.41	203.97	L <sub>s</sub> = 460 mm
∅ 8-20	188.26	199.37	204.93	210.48	216.04	221.59	227.15	232.71	
∅ 8-15	236.20	247.31	252.87	258.42	263.98	269.53	275.09	280.64	
∅ 8-10	332.08	343.19	348.74	354.30	359.86	365.41	370.97	376.52	

The verification of the pull-out lengths in construction section 2 must be carried out by the user!

Valid until 31/03/2019

Type test

Tested with regard to stability

See test report SLA 130164 of 20/03/2014

LGA Prüfamt für Standsicherheit

der Zweigstelle Landshut

Landshut, 30/03/2014

# Non-certified translation from the German original.

Result  $V_{Rd}$  [kN/m] Concrete quality C20/25 Transverse force vertical - Case c Data sheet Reverse bending acc. to EC, Figure 8  
The requirements for consideration of the bracket support component in accordance with DBV data sheet Section 5.3 (6) shall be met.

Nevoga Plexus Type B

d=	100 mm	120 mm	140 mm	160 mm	180 mm	200 mm	220 mm	240 mm	260 mm	280 mm
----	--------	--------	--------	--------	--------	--------	--------	--------	--------	--------

h=	150 mm	150 mm	150 mm	150 mm	150 mm	150 mm	150 mm	150 mm	150 mm	150 mm
Ø – Partition [mm]										
8 - 250	44.27	45.00	45.00	45.00	45.00	45.00	45.00	45.00	45.00	45.00
8 – 200	44.27	49.42	52.97	56.25	56.25	56.25	56.25	56.25	56.25	56.25
8 – 150	44.27	49.42	52.97	56.51	60.05	63.59	65.78	67.93	70.04	72.11
8 – 100	44.27	49.42	52.97	56.51	60.05	63.59	65.78	67.93	70.04	72.11

h=	150 mm	150 mm	150 mm	150 mm	150 mm	150 mm	150 mm	150 mm	150 mm	150 mm
10 - 250	44.27	53.13	56.25	56.25	56.25	56.25	56.25	56.25	56.25	56.25
10 – 200	44.27	53.13	58.60	62.14	65.69	69.23	70.31	70.31	70.31	70.31
10 – 150	44.27	53.13	58.60	62.14	65.69	69.23	71.42	73.56	75.67	77.75
10 – 100	50.09	56,43	58.88	62.14	65.69	69.23	71.42	73.56	75.67	77.75

h=	170 mm	170 mm	170 mm	170 mm	170 mm	170 mm	170 mm	170 mm	170 mm	170 mm
12 - 250	Production technically not possible	53.13	58.60	62.14	65.69	69.23	71.42	73.56	75.67	76.50
12 – 200		53.13	58.60	62.14	65.69	69.23	71.42	73.56	75.67	77.75
12 – 150		55.80	58.60	62.14	65.69	69.23	71.42	73.56	75.67	77.75
12 – 100		59.36	62.12	64.76	67.29	69.72	71.42	73.56	75.67	77.75

The verification of the pull-out lengths in construction section 2 must be carried out by the user!  
The tensile force cover must be verified by the user in the pull-out area of the reverse bend connection!  
According to DIN EN 1992-1-1, section 9.3.1.2, paragraph (1), at least half of the field reinforcement of solid slabs must be guided to the support and anchored there!

[www.nevoga.de](http://www.nevoga.de)

NEVOGA GmbH – Znaimer Str. 4 – D-83395 Freilassing – Telephone: 0049/8654/47310 – Fax: 0049/8654/4731 – 18

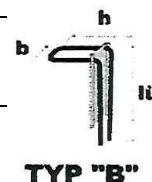

Valid until 31/03/2019

Type test

Tested with regard to stability

See test report SLA 130164 of 20/03/2014

LGA Prüfamf für Standsicherheit

der Zweigstelle Landshut

Landshut, 30/03/2014

**Non-certified translation from the German original.**

Result  $V_{rd}$  [kN/m] Concrete quality C20/25 with transverse force reinforcement Transverse force vertical - Case c Data sheet  
Reverse bending according to EC, Figure 8  
Nevoga Plexus Type B

d=	140 mm	160 mm	180 mm	200 mm	220 mm	240 mm	260 mm	280 mm
----	--------	--------	--------	--------	--------	--------	--------	--------

h=	150 mm	150 mm	150 mm	150 mm	150 mm	150 mm	150 mm	150 mm
----	--------	--------	--------	--------	--------	--------	--------	--------

∅ – Partition [mm]								
8 - 250	83.33	83.33	83.33	83.33	83.33	83.33	83.33	83.33
8 - 200	94.06	104.16	104.16	104.16	104.16	104.16	104.16	104.16
8 - 150	94.06	119.14	138.88	138.88	138.88	138.88	138.88	138.88
8 - 100	94.06	119.14	144.22	169.30	194.39	208.33	208.33	208.33

h=	150 mm	150 mm	150 mm	150 mm	150 mm	150 mm	150 mm	150 mm
10 - 250	94.06	104.16	104.16	104.16	104.16	104.16	104.16	104.16
10 - 200	94.06	119.14	130.20	130.20	130.20	130.20	130.20	130.20
10 - 150	94.06	119.14	144.22	169.30	173.61	173.61	173.61	173.61
10 - 100	94.06	119.14	144.22	169.30	194.39	219.47	244.55	260.41

h=	170 mm	170 mm	170 mm	170 mm	170 mm	170 mm	170 mm	170 mm
12 - 250	94.06	119.14	141.66	141.66	141.66	141.66	141.66	141.66
12 - 200	94.06	119.14	141.22	169.30	177.08	177.08	177.08	177.08
12 - 150	94.06	119.14	141.22	169.30	194.39	219.47	236.10	236.10
12 - 100	94.06	119.14	141.22	169.30	194.39	219.47	244.55	269.63

The required transverse force reinforcement for vertical stirrups shall be calculated assuming  $\cot \theta = 1$  according to the following equation:  $\text{erf. } a_{sw} = V_{ed}/(f_{ywd} \cdot z)$

The verification of the pull-out lengths in construction section 2 must be carried out by the user!

The tensile force cover must be verified by the user in the pull-out area of the reverse bend connection!

According to DIN EN 1992-1-1, section 9.3.1.2, paragraph (1), at least half of the field reinforcement of solid slabs must be guided to the support and anchored there!

According to DIN EN 1992-1-1, section 9.3.2 (1), the minimum thicknesses of the solid slabs for the arrangement of a transverse force reinforcement must be observed!

[www.nevoga.de](http://www.nevoga.de)

NEVOGA GmbH – Znaimer Str. 4 – D-83395 Freilassing – Telephone: 0049/8654/47310 – Fax: 0049/8654/4731 – 18

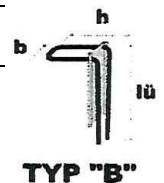

Valid until 31/03/2019

Type test

Tested with regard to stability  
See test report SLA 130164 of 20/03/2014

LGA Prüfamf für Standsicherheit

der Zweigstelle Landshut

Landshut, 30/03/2014



# Non-certified translation from the German original.

Fritsche Ingenieure  
Ingenieurbüro für Bauwesen

Page 12

Result  $V_{Rd}$  [kN/m] Concrete quality C20/25 Transverse force vertical - Case c Data sheet Reverse bending acc. to EC, Figure 8  
The requirements for consideration of the bracket support component in accordance with DBV data sheet Section 5.3 (6) shall be met.

Nevoga Plexus Type B

d=	100 mm	120 mm	140 mm	160 mm	180 mm	200 mm	220 mm	240 mm	260 mm	280 mm
----	--------	--------	--------	--------	--------	--------	--------	--------	--------	--------

h=	150 mm	150 mm	150 mm	150 mm	150 mm	150 mm	150 mm	150 mm	150 mm	150 mm
Ø – Partition [mm]										
8 - 250	49.50	52.22	52.22	52.22	52.22	52.22	52.22	52.22	52.22	52.22
8 - 200	49.50	56.45	60.41	64.37	65.27	65.27	65.27	65.27	65.27	65.27
8 - 150	49.50	56.45	60.41	64.37	68.33	72.29	74.74	77.14	79.50	81.82
8 - 100	49.50	56.45	60.41	64.37	68.33	72.29	74.74	77.14	79.50	81.82

h=	150 mm	150 mm	150 mm	150 mm	150 mm	150 mm	150 mm	150 mm	150 mm	150 mm
10 - 250	49.50	65.27	65.27	65.27	65.27	65.27	65.27	65.27	65.27	65.27
10 - 200	49.50	65.95	70.91	74.87	78.83	81.82	81.59	81.59	81.59	81.59
10 - 150	49.50	65.95	70.91	74.87	78.83	81.82	81.59	86.04	86.04	88.36
10 - 100	49.50	65.95	70.91	74.87	78.83	81.82	81.59	86.04	86.04	88.36

h=	170 mm	170 mm	170 mm	170 mm	170 mm	170 mm	170 mm	170 mm	170 mm	170 mm
12 - 250	Production technically not possible	59.40	65.95	70,91	74.87	78.83	81.28	83,68	86.04	88.36
12 - 200		59.40	65.95	70,91	74.87	78.83	81.28	83,68	86.04	88.36
12 - 150		6560.11	65.95	70,91	74.87	78.83	81.28	83,68	86.04	88.36
12 - 100		65.75	69,73	72,57	74.30	78.83	81.28	83,68	86.04	88.36

The verification of the pull-out lengths in construction section 2 must be carried out by the user!

The tensile force cover must be verified by the user in the pull-out area of the reverse bend connection!

According to DIN EN 1992-1-1, section 9.3.1.2, paragraph (1), at least half of the field reinforcement of solid slabs must be guided to the support and anchored there!

[www.nevoga.de](http://www.nevoga.de)

NEVOGA GmbH – Znaimer Str. 4 – D-83395 Freilassing – Telephone: 0049/8654/47310 – Fax: 0049/8654/4731 – 18

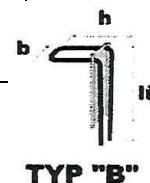

Valid until 31/03/2019

Type test

Tested with regard to stability

See test report SLA 130164 of 20/03/2014

LGA Prüfamt für Standsicherheit

der Zweigstelle Landshut

Landshut, 30/03/2014

# Non-certified translation from the German original.

Fritsche Ingenieure  
Ingenieurbüro für Bauwesen

Page 13

Result  $V_{rd}$  [kN/m] Concrete quality C25/30 with transverse force reinforcement Transverse force vertical - Case c Data sheet  
Reverse bending according to EC, Figure 8  
Nevoga Plexus Type B

d=	140 mm	160 mm	180 mm	200 mm	220 mm	240 mm	260 mm	280 mm
----	--------	--------	--------	--------	--------	--------	--------	--------

h=	150 mm	150 mm	150 mm	150 mm	150 mm	150 mm	150 mm	150 mm
----	--------	--------	--------	--------	--------	--------	--------	--------

Ø - Partition [mm]								
8 - 250	96.70	96.70	96.70	96.70	96.70	96.70	96.70	96.70
8 - 200	117.57	120.87	120.87	120.87	120.87	120.87	120.87	120.87
8 - 150	117.57	148.92	161.16	161.16	161.16	161.16	161.16	161.16
8 - 100	117.57	148.92	180.28	211.63	241.74	241.74	241.74	241.74

h=	150 mm	150 mm	150 mm	150 mm	150 mm	150 mm	150 mm	150 mm
10 - 250	117.57	120.87	120.87	120.87	120.87	120.87	120.87	120.87
10 - 200	117.57	148.92	151.09	151.09	151.09	151.09	151.09	151.09
10 - 150	117.57	148.92	180.28	201.45	201.45	201.45	201.45	201.45
10 - 100	117.57	148.92	180.28	211.63	242.98	247.33	302.18	302.18

h=	170 mm	170 mm	170 mm	170 mm	170 mm	170 mm	170 mm	170 mm
12 - 250	117.57	148.92	164.38	164.38	164.38	164.38	164.38	164.38
12 - 200	117.57	148.92	180.28	205.48	205.48	205.48	205.48	205.48
12 - 150	117.57	148.92	180.28	211.63	242.98	273.97	273.97	273.97
12 - 100	117.57	148.92	180.28	211.63	242.98	274.33	305.69	337.04

The required transverse force reinforcement for vertical stirrups shall be calculated assuming  $\cot \theta = 1$  according to the following equation:  $a_{sw} = V_{ed} / (f_{ywd} \cdot z)$

The verification of the pull-out lengths in construction section 2 must be carried out by the user!

The tensile force cover must be verified by the user in the pull-out area of the reverse bend connection!

According to DIN EN 1992-1-1, section 9.3.1.2, paragraph (1), at least half of the field reinforcement of solid slabs must be guided to the support and anchored there!

According to DIN EN 1992-1-1, section 9.3.2 (1), the minimum thicknesses of the solid slabs for the arrangement of a transverse force reinforcement must be observed!

[www.nevoga.de](http://www.nevoga.de)

NEVOGA GmbH – Znaimer Str. 4 – D-83395 Freilassing – Telephone: 0049/8654/47310 – Fax: 0049/8654/4731 – 18



**Non-certified translation from the German original.**

Fritsche Ingenieure

Ingenieurbüro für Bauwesen

Page 14

Result  $V_{rd}$  [kN/m] Concrete quality C30/37 Transverse force vertical - Case c Data sheet Reverse bending acc. to EC, Figure 8  
The requirements for consideration of the bracket support component in accordance with DBV data sheet Section 5.3 (6) shall be met.

Nevoga Plexus Type B

d=	100 mm	120 mm	140 mm	160 mm	180 mm	200 mm	220 mm	240 mm	260 mm	280 mm
----	--------	--------	--------	--------	--------	--------	--------	--------	--------	--------

h=	150 mm	150 mm	150 mm	150 mm	150 mm	150 mm	150 mm	150 mm	150 mm	150 mm
----	--------	--------	--------	--------	--------	--------	--------	--------	--------	--------

Ø – Partition [mm]										
8 - 250	54.22	58.96	58.96	58.96	58.96	58.96	58.96	58.96	58.96	58.96
8 - 200	54.22	62.95	67.28	71.62	73.71	73.71	73.71	73.71	73.71	73.71
8 - 150	54.22	62.95	67.28	71.62	75.96	80.30	82.98	85.61	88.19	90.73
8 - 100	54.22	62.95	67.28	71.62	75.96	80.30	82.98	85.61	88.19	90.73

h=	150 mm	150 mm	150 mm	150 mm	150 mm	150 mm	150 mm	150 mm	150 mm	150 mm
10 - 250	54.22	65.07	73.71	73.71	73.71	73.71	73.71	73.71	73.71	73.71
10 - 200	54.22	65.07	74.67	79.00	83.34	87.68	90.36	92.13	92.13	92.13
10 - 150	54.22	65.07	74.67	79.00	83.34	87.68	90.36	92.99	95.57	98.12
10 - 100	57.34	65.07	74.67	79.00	83.34	87.68	90.36	92.99	95.57	98.12

h=	170 mm	170 mm	170 mm	170 mm	170 mm	170 mm	170 mm	170 mm	170 mm	170 mm
12 - 250	Production technically not possible	65.07	74.67	79.00	83.34	87.68	90.36	92.99	95.57	98.12
12 - 200		65.07	74.67	79.00	83.34	87.68	90.36	92.99	95.57	98.12
12 - 150		65.07	74.67	79.00	83.34	87.68	90.36	92.99	95.57	98.12
12 - 100		73.12	76.71	79.73	83.34	87.68	90.36	92.99	95.57	98.12

The verification of the pull-out lengths in construction section 2 must be carried out by the user!  
The tensile force cover must be verified by the user in the pull-out area of the reverse bend connection!  
According to DIN EN 1992-1-1, section 9.3.1.2, paragraph (1), at least half of the field reinforcement of solid slabs must be guided to the support and anchored there!

[www.nevoga.de](http://www.nevoga.de)  
NEVOGA GmbH – Znaimer Str. 4 – D-83395 Freilassing – Telephone: 0049/8654/47310 – Fax: 0049/8654/4731 - 18



Valid until 31/03/2019

Type test

Tested with regard to stability

See test report SLA 130164 of 20/03/2014

LGA Prüfamf für Standsicherheit

der Zweigstelle Landshut

Landshut, 30/03/2014

# Non-certified translation from the German original.

Fritsche Ingenieure  
Ingenieurbüro für Bauwesen

Page 15

Result  $V_{rd}$  [kN/m] Concrete quality C30/37 with transverse force reinforcement Transverse force vertical - Case c Data sheet  
Reverse bending according to EC, Figure 8  
Nevoga Plexus Type B

d=	140 mm	160 mm	180 mm	200 mm	220 mm	240 mm	260 mm	280 mm
----	--------	--------	--------	--------	--------	--------	--------	--------

h=	150 mm	150 mm	150 mm	150 mm	150 mm	150 mm	150 mm	150 mm
----	--------	--------	--------	--------	--------	--------	--------	--------

∅ – Partition [mm]								
8 - 250	109.19	109.19	109.19	109.19	109.19	109.19	109.19	109.19
8 - 200	136.49	136.49	136.49	136.49	136.49	136.49	136.49	136.49
8 - 150	141.09	178.71	181.99	181.99	181.99	181.99	181.99	181.99
8 - 100	141.09	178.71	216.33	253.95	272.99	272.99	272.99	272.99

h=	150 mm	150 mm	150 mm	150 mm	150 mm	150 mm	150 mm	150 mm
10 - 250	136.49	136.49	136.49	136.49	136.49	136.49	136.49	136.49
10 - 200	141.09	170.62	170.62	170.62	170.62	170.62	170.62	170.62
10 - 150	141.09	178.71	216.33	227.49	227.49	227.49	227.49	227.49
10 - 100	141.09	178.71	216.33	235.95	291.58	329.20	341.23	341.23

h=	170 mm	170 mm	170 mm	170 mm	170 mm	170 mm	170 mm	170 mm
12 - 250	141.09	178.71	185.63	185.63	185.63	185.63	185.63	185.63
12 - 200	141.09	178.71	216.33	232.04	232.04	232.04	232.04	232.04
12 - 150	141.09	178.71	216.33	235.95	291.58	309.38	309.38	309.38
12 - 100	141.09	178.71	216.33	235.95	291.58	329.20	366.82	404.45

The required transverse force reinforcement for vertical stirrups shall be calculated assuming  $\cot \theta = 1$  according to the following equation:  $a_{sw} = V_{ed} / (f_{ywd} * z)$

The verification of the pull-out lengths in construction section 2 must be carried out by the user!

The tensile force cover must be verified by the user in the pull-out area of the reverse bend connection!

According to DIN EN 1992-1-1, section 9.3.1.2, paragraph (1), at least half of the field reinforcement of solid slabs must be guided to the support and anchored there!

According to DIN EN 1992-1-1, section 9.3.2 (1), the minimum thicknesses of the solid slabs for the arrangement of a transverse force reinforcement must be observed!

[www.nevoga.de](http://www.nevoga.de)

NEVOGA GmbH – Znaimer Str. 4 – D-83395 Freilassing – Telephone: 0049/8654/47310 – Fax: 0049/8654/4731 – 18

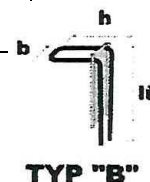

Valid until 31/03/2019

Type test

Tested with regard to stability

See test report SLA 130164 of 20/03/2014

LGA Prüfamts für Standsicherheit

der Zweigstelle Landshut

Landshut, 30/03/2014

# Non-certified translation from the German original.

Fritsche Ingenieure

Ingenieurbüro für Bauwesen

Result

$V_{Rd}$	[kN/m]	Concrete quality	C20/25
Transverse force vertical - Case d data sheet Reverse bending to EC 2, Fig. 8			
Data sheet reverse bending figure 8d			
Good bond conditions according to DIN EN 1992-1-1			
$\sigma_{cd}$	=	0	$b_w = 1.0 m$
Nevoga Plexus Type DD			

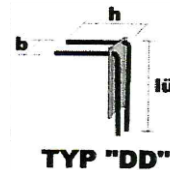

Box width	85 mm	115 mm	145 mm	175 mm	205 mm	225 mm
d=	72.5 mm	102.5 mm	132.5 mm	162.5 mm	192.5 mm	212.5 mm

h=	350 mm	350 mm	350 mm	350 mm	350 mm	350 mm	
Ø - Partition [mm]							
8 - 250	12.84	18.15	23.46	28.78	34.09	36.79	L <sub>s</sub> = 320 mm
8 - 200	12.84	18.15	23.46	28.78	34.09	36.79	
8 - 150	12.84	18.15	23.46	28.78	34.09	36.79	
8 - 100	13.93	18.15	23.46	28.78	34.09	36.79	

h=	430 mm	430 mm	430 mm	430 mm	430 mm	430 mm	L <sub>s</sub> = 390 mm
10 - 250	12.84	18.15	23.46	28.78	34.09	36.79	
10 - 200	12.84	18.15	23.46	28.78	34.09	36.79	
10 - 150	14.13	18.15	23.46	28.78	34.09	36.79	
10 - 100	16.17	20.37	24.17	28.78	34.09	36.79	

h=	510 mm	510 mm	510 mm	510 mm	510 mm	510 mm	L <sub>s</sub> = 460 mm
12 - 250	13.45	18.15	23.46	28.78	34.09	36.79	
12 - 200	14.49	18.26	23.46	28.78	34.09	36.79	
12 - 150	15.95	20.09	23.84	28.78	34.09	36.79	
12 - 100	18.26	23.00	27.29	31.27	35.01	36.84	

The verification of the pull-out lengths in construction section 2 must be carried out by the user!  
 The tensile force cover must be verified by the user in the pull-out area of the reverse bend connection!  
 According to DIN EN 1992-1-1, section 9.3.1.2, paragraph (1), at least half of the field reinforcement of solid slabs must be guided to the support and anchored there!

[www.nevoga.de](http://www.nevoga.de)

NEVOGA GmbH – Znaimer Str. 4 – D-83395 Freilassing – Telephone: 0049/8654/47310 – Fax: 0049/8654/4731 - 18

Valid until 31/03/2019

Type test

Tested with regard to stability  
See test report SLA 130164 of 20/03/2014

LGA Prüfamt für Standsicherheit  
 der Zweigstelle Landshut

Landshut, 30/03/2014

Result

$V_{Rd}$	[kN/m]	Concrete quality	C25/30
Transverse force vertical - Case d data sheet Reverse bending to EC 2, Fig. 8			
Data sheet reverse bending figure 8d			
Good bond conditions according to DIN EN 1992-1-1			
$\sigma_{cd}$	=	0	$b_w = 1.0$ m
Nevoga Plexus Type DD			

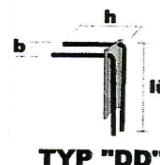

Box width	85 mm	115 mm	145 mm	175 mm	205 mm	225 mm
d=	72.5 mm	102.5 mm	132.5 mm	162.5 mm	192.5 mm	212.5 mm

h=	350 mm	350 mm	350 mm	350 mm	350 mm	350 mm	
$\emptyset$ - Partition [mm]							
8 - 250	14.35	20.29	26.33	32.17	38.11	41.13	L <sub>s</sub> = 320 mm
8 - 200	14.35	20.29	26.33	32.17	38.11	41.13	
8 - 150	14.35	20.29	26.33	32.17	38.11	41.13	
8 - 100	14.35	20.29	26.33	32.17	38.11	41.13	

h=	430 mm	430 mm	430 mm	430 mm	430 mm	430 mm	L <sub>s</sub> = 390 mm
10 - 250	14.35	20.29	26.33	32.17	38.11	41.13	
10 - 200	14.35	20.29	26.33	32.17	38.11	41.13	
10 - 150	15.22	20.29	26.33	32.17	38.11	41.13	
10 - 100	17.42	21.94	26.33	32.17	38.11	41.13	

h=	510 mm	510 mm	510 mm	510 mm	510 mm	510 mm	L <sub>s</sub> = 460 mm
12 - 250	14.49	20.29	26.33	32.17	38.11	41.13	
12 - 200	15.61	20.29	26.33	32.17	38.11	41.13	
12 - 150	17.18	21.64	26.33	32.17	38.11	41.13	
12 - 100	19.67	24.78	29.40	33.69	38.11	41.13	

The verification of the pull-out lengths in construction section 2 must be carried out by the user!  
The tensile force cover must be verified by the user in the pull-out area of the reverse bend connection!  
According to DIN EN 1992-1-1, section 9.3.1.2, paragraph (1), at least half of the field reinforcement of solid slabs must be guided to the support and anchored there!

[www.nevoga.de](http://www.nevoga.de)

NEVOGA GmbH – Znaimer Str. 4 – D-83395 Freilassing – Telephone: 0049/8654/47310 – Fax: 0049/8654/4731 - 18

Valid until 31/03/2019

Type test

Tested with regard to stability  
See test report SLA 130164 of 20/03/2014

LGA Prüfamt für Standsicherheit  
der Zweigstelle Landshut

Landshut, 30/03/2014

# Non-certified translation from the German original.

Fritsche Ingenieure

Ingenieurbüro für Bauwesen

Result

$V_{Rd}$	[kN/m]	Concrete quality	C30/37
Transverse force vertical - Case d data sheet Reverse bending to EC 2, Fig. 8			
Data sheet reverse bending figure 8 d			
Good bond conditions according to DIN EN 1992-1-1			
$\sigma_{cd}$	=	0	$b_w = 1.0$ m
Nevoga Plexus Type DD			

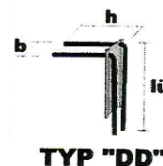

Box width	85 mm	115 mm	145 mm	175 mm	205 mm	225 mm
d=	72.5 mm	102.5 mm	132.5 mm	162.5 mm	192.5 mm	212.5 mm

h=	350 mm	350 mm	350 mm	350 mm	350 mm	350 mm	
Ø - Partition [mm]							
8 - 250	15.72	22.23	28.74	35.24	41.75	45.06	L <sub>s</sub> = 320 mm
8 - 200	15.72	22.23	28.74	35.24	41.75	45.06	
8 - 150	15.72	22.23	28.74	35.24	41.75	45.06	
8 - 100	15.72	22.23	28.74	35.24	41.75	45.06	

h=	430 mm	430 mm	430 mm	430 mm	430 mm	430 mm	L <sub>s</sub> = 390 mm
10 - 250	15.72	22.23	28.74	35.24	41.75	45.06	
10 - 200	15.72	22.23	28.74	35.24	41.75	45.06	
10 - 150	16.17	22.23	28.74	35.24	41.75	45.06	
10 - 100	18.51	22.23	28.74	35.24	41.75	45.06	

h=	510 mm	510 mm	510 mm	510 mm	510 mm	510 mm	L <sub>s</sub> = 460 mm
12 - 250	15.72	22.23	28.74	35.24	41.75	45.06	
12 - 200	16.59	22.23	28.74	35.24	41.75	45.06	
12 - 150	18.26	23.00	28.74	35.24	41.75	45.06	
12 - 100	20.90	26.33	31.24	35.80	41.75	45.06	

The verification of the pull-out lengths in construction section 2 must be carried out by the user!  
 The tensile force cover must be verified by the user in the pull-out area of the reverse bend connection!  
 According to DIN EN 1992-1-1, section 9.3.1.2, paragraph (1), at least half of the field reinforcement of solid slabs must be guided to the support and anchored there!

[www.nevoga.de](http://www.nevoga.de)

NEVOGA GmbH – Znaimer Str. 4 – D-83395 Freilassing – Telephone: 0049/8654/47310 – Fax: 0049/8654/4731 - 18

Valid until 31/03/2019

Type test

Tested with regard to stability  
See test report SLA 130164 of 20/03/2014

LGA Prüfamf für Standsicherheit  
 der Zweigstelle Landshut

Landshut, 30/03/2014

# Non-certified translation from the German original.

Fritsche Ingenieure

Ingenieurbüro für Bauwesen

Result

$V_{Rd}$	[kN/m]	Concrete quality	C20/25
Transverse force vertical - Case e data sheet Reverse bending to EC 2, Fig. 8			
Data sheet reverse bending figure 8e			
Good bond conditions according to DIN EN 1992-1-1			
$\sigma_{cd}$	=	0	$b_w = 1.0$ m
Nevoga Plexus Type B			

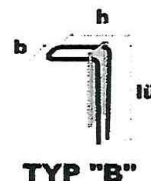

Box width	85 mm	115 mm	145 mm	175 mm	205 mm	225 mm
d=	72.5 mm	102.5 mm	132.5 mm	162.5 mm	192.5 mm	212.5 mm

h=	150 mm	150 mm	150 mm	150 mm	150 mm	150 mm	
Ø - Partition [mm]							
8 - 250	12.84	18.15	23.46	28.78	34.09	36.79	L <sub>s</sub> = 320 mm
8 - 200	12.84	18.15	23.46	28.78	34.09	36.79	
8 - 150	12.84	18.15	23.46	28.78	34.09	36.79	
8 - 100	13.93	18.15	23.46	28.78	34.09	36.79	

h=	150 mm	150 mm	150 mm	150 mm	150 mm	150 mm	L <sub>s</sub> = 390 mm
10 - 250	12.84	18.15	23.46	28.78	34.09	36.79	
10 - 200	12.84	18.15	23.46	28.78	34.09	36.79	
10 - 150	14.13	18.15	23.46	28.78	34.09	36.79	
10 - 100	16.17	20.37	24.17	28.78	34.09	36.79	

h=	170 mm	170 mm	170 mm	170 mm	170 mm	170 mm	L <sub>s</sub> = 460 mm
12 - 250	Production technically not possible	18.15	23.46	28.78	34.09	36.79	
12 - 200		18.26	23.46	28.78	34.09	36.79	
12 - 150		20.09	23.84	28.78	34.09	36.79	
12 - 100		23.00	27.29	31.27	35.01	36.84	

The verification of the pull-out lengths in construction section 2 must be carried out by the user!  
 The tensile force cover must be verified by the user in the pull-out area of the reverse bend connection!  
 According to DIN EN 1992-1-1, section 9.3.1.2, paragraph (1), at least half of the field reinforcement of solid slabs must be guided to the support and anchored there!

[www.nevoga.de](http://www.nevoga.de)

NEVOGA GmbH – Znaimer Str. 4 – D-83395 Freilassing – Telephone: 0049/8654/47310 – Fax: 0049/8654/4731 - 18

Valid until 31/03/2019

Type test

Tested with regard to stability  
See test report SLA 130164 of 20/03/2014

LGA Prüfamt für Standsicherheit  
 der Zweigstelle Landshut

Landshut, 30/03/2014



# Non-certified translation from the German original.

Result

$V_{Rd}$	[kN/m]	Concrete quality	C20/25
Transverse force vertical - Case e data sheet Reverse bending to EC 2, Fig. 8			
Data sheet reverse bending figure 8e			
Good bond conditions according to DIN EN 1992-1-1			
$\sigma_{cd}$	=	0	$b_w = 1.0\text{ m}$ $C_{nom} = 35$
mm			
Nevoga Plexus Type B			

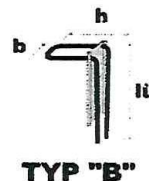

Box width	85 mm	115 mm	145 mm	175 mm	205 mm	225 mm
d=	72.5 mm	102.5 mm	132.5 mm	162.5 mm	192.5 mm	212.5 mm

h=	150 mm	150 mm	150 mm	150 mm	150 mm	150 mm	
Ø – Partition [mm]							
8 - 250	Production technically not possible	47.03	83.33	83.33	83.33	83.33	$L_s = 320$ mm
8 - 200		47.03	84.65	104.16	104.16	104.16	
8 - 150		47.03	84.65	122.27	138.88	138.88	
8 - 100		47.03	84.65	122.27	159.90	184.98	

h=	150 mm	150 mm	150 mm	150 mm	150 mm	150 mm	$L_s = 390$ mm
10 - 250	Production technically not possible	47.03	84.65	104.16	104.16	104.16	
10 - 200		47.03	84.65	122.27	130.20	130.20	
10 - 150		47.03	84.65	122.27	159.90	173.61	
10 - 100		47.03	84.65	122.27	159.90	184.98	

h=	170 mm	170 mm	170 mm	170 mm	170 mm	170 mm	
12 - 250	Production technically not possible	47.03	84.65	122.27	141.66	141.66	$L_s = 460$ mm
12 - 200		47.03	84.65	122.27	159.90	177.08	
12 - 150		47.03	84.65	122.27	159.90	184.98	
12 - 100		47.03	84.65	122.27	159.90	184.98	

The required transverse force reinforcement for vertical stirrups shall be calculated assuming  $\cot \theta = 1$  according to the following equation:  $\text{erf. } a_{sw} = V_{ed} / (f_{ywd} * z)$   
 The verification of the pull-out lengths in construction section 2 must be carried out by the user!  
 The tensile force cover must be verified by the user in the pull-out area of the reverse bend connection!  
 According to DIN EN 1992-1-1, section 9.3.1.2, paragraph (1), at least half of the field reinforcement of solid slabs must be guided to the support and anchored there!

[www.nevoga.de](http://www.nevoga.de)

NEVOGA GmbH – Znaimer Str. 4 – D-83395 Freilassing – Telephone: 0049/8654/47310 – Fax: 0049/8654/4731 - 18

Valid until 31/03/2019

Type test

Tested with regard to stability  
See test report SLA 130164 of 20/03/2014

LGA Prüfamt für Standsicherheit  
der Zweigstelle Landshut

Landshut, 30/03/2014

Result

$V_{Rd}$	[kN/m]	Concrete quality	C25/30
Transverse force vertical - Case e data sheet Reverse bending to EC 2, Fig. 8			
Data sheet reverse bending figure 8 e			
Good bond conditions according to DIN EN 1992-1-1			
$\sigma_{cd}$	=	0	$b_w = 1.0$ m
Nevoga Plexus Type B			

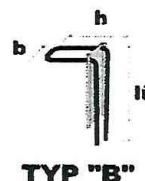

Box width	85 mm	115 mm	145 mm	175 mm	205 mm	225 mm
d=	72.5 mm	102.5 mm	132.5 mm	162.5 mm	192.5 mm	212.5 mm

h=	150 mm	150 mm	150 mm	150 mm	150 mm	150 mm	
Ø - Partition [mm]							
8 - 250	14.35	20.29	26.23	32.17	38.11	41.13	L <sub>s</sub> = 320 mm
8 - 200	14.35	20.29	26.23	32.17	38.11	41.13	
8 - 150	14.35	20.29	26.23	32.17	38.11	41.13	
8 - 100	15.01	20.29	26.23	32.17	38.11	41.13	

h=	150 mm	150 mm	150 mm	150 mm	150 mm	150 mm	L <sub>s</sub> = 390 mm
10 - 250	14.35	20.29	26.33	32.17	38.11	41.13	
10 - 200	14.35	20.29	26.33	32.17	38.11	41.13	
10 - 150	15.22	20.29	26.33	32.17	38.11	41.13	
10 - 100	17.42	21.94	26.33	32.17	38.11	41.13	

h=	170 mm	170 mm	170 mm	170 mm	170 mm	170 mm	
12 - 250	Production technically not possible!	20.29	26.33	32.17	38.11	41.13	L <sub>s</sub> = 460 mm
12 - 200		20.29	26.33	32.17	38.11	41.13	
12 - 150		21.64	26.33	32.17	38.11	41.13	
12 - 100		24.78	29.40	33.69	38.11	41.13	

The verification of the pull-out lengths in construction section 2 must be carried out by the user!  
The tensile force cover must be verified by the user in the pull-out area of the reverse bend connection!  
According to DIN EN 1992-1-1, section 9.3.1.2, paragraph (1), at least half of the field reinforcement of solid slabs must be guided to the support and anchored there!

[www.nevoga.de](http://www.nevoga.de)  
NEVOGA GmbH – Znaimer Str. 4 – D-83395 Freilassing – Telephone: 0049/8654/47310 – Fax: 0049/8654/4731 - 18

Valid until 31/03/2019

Type test

Tested with regard to stability  
See test report SLA 130164 of 20/03/2014

LGA Prüfamf für Standsicherheit  
der Zweigstelle Landshut

Landshut, 30/03/2014

Result

$V_{Rd}$	[kN/m]	Concrete quality	C25/30
Transverse force vertical - Case e data sheet Reverse bending to EC 2, Fig. 8			
Data sheet reverse bending figure 8e			
Good bond conditions according to DIN EN 1992-1-1			
$\sigma_{cd}$	=	0	$b_w = 1.0 \text{ m}$ $C_{nom} = 35 \text{ mm}$
Nevoga Plexus Type B			

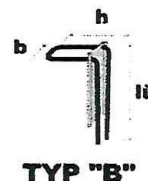

Box width	85 mm	115 mm	145 mm	175 mm	205 mm	225 mm
d=	72.5 mm	102.5 mm	132.5 mm	162.5 mm	192.5 mm	212.5 mm

h=	150 mm	150 mm	150 mm	150 mm	150 mm	150 mm	
Ø - Partition [mm]							
8 - 250	Production technically not possible	58.79	96.70	96.70	96.70	96.70	L <sub>s</sub> = 320 mm
8 - 200		58.79	105.81	120.87	120.87	120.87	
8 - 150		58.79	105.81	152.84	161.16	161.16	
8 - 100		58.79	105.81	152.84	199.87	231.22	

h=	150 mm	150 mm	150 mm	150 mm	150 mm	150 mm	L <sub>s</sub> = 390 mm
10 - 250	Production technically not possible	58.79	105.81	120.87	120.87	120.87	
10 - 200		58.79	105.81	151.09	151.09	151.09	
10 - 150		58.79	105.81	152.84	191.87	201.45	
10 - 100		58.79	105.81	152.84	199.87	231.22	

h=	170 mm	170 mm	170 mm	170 mm	170 mm	170 mm	
12 - 250	Production technically not possible	58.79	105.81	152.84	164.38	164.38	L <sub>s</sub> = 460 mm
12 - 200		58.79	105.81	152.84	191.87	205.48	
12 - 150		58.79	105.81	152.84	191.87	231.22	
12 - 100		58.79	105.81	152.84	199.87	231.22	

The required transverse force reinforcement for vertical stirrups shall be calculated assuming  $\cot \theta = 1$  according to the following equation:  $\text{erf. } a_{sw} = V_{ed} / (f_{ywd} * z)$   
 The verification of the pull-out lengths in construction section 2 must be carried out by the user!  
 The tensile force cover must be verified by the user in the pull-out area of the reverse bend connection!  
 According to DIN EN 1992-1-1, section 9.3.1.2, paragraph (1), at least half of the field reinforcement of solid slabs must be guided to the support and anchored there!

[www.nevoga.de](http://www.nevoga.de)  
 NEVOGA GmbH – Znaimer Str. 4 – D-83395 Freilassing – Telephone: 0049/8654/47310 – Fax: 0049/8654/4731 - 18

Valid until 31/03/2019

Type test

Tested with regard to stability  
See test report SLA 130164 of 20/03/2014

LGA Prüfamnt für Standsicherheit  
 der Zweigstelle Landshut

Landshut, 30/03/2014

# Non-certified translation from the German original.

Result

$V_{Rd}$	[kN/m]	Concrete quality	C30/37
Transverse force vertical - Case e data sheet Reverse bending to EC 2, Fig. 8			
Data sheet reverse bending figure 8e			
Good bond conditions according to DIN EN 1992-1-1			
$\sigma_{cd}$	=	0	$b_w = 1.0$ m
Nevoga Plexus Type B			

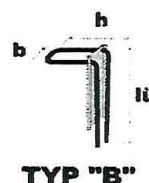

Box width	85 mm	115 mm	145 mm	175 mm	205 mm	225 mm
d=	72.5 mm	102.5 mm	132.5 mm	162.5 mm	192.5 mm	212.5 mm

h=	150 mm	150 mm	150 mm	150 mm	150 mm	150 mm	
Ø - Partition [mm]							
8 - 250	15.72	22.23	28.74	35.24	41.75	45.06	L <sub>s</sub> = 320 mm
8 - 200	15.72	22.23	28.74	35.24	41.75	45.06	
8 - 150	15.72	22.23	28.74	35.24	41.75	45.06	
8 - 100	15.95	22.23	28.74	35.24	41.75	45.06	

h=	150 mm	150 mm	150 mm	150 mm	150 mm	150 mm	L <sub>s</sub> = 390 mm
10 - 250	15.72	22.23	28.74	35.24	41.75	45.06	
10 - 200	15.72	22.23	28.74	35.24	41.75	45.06	
10 - 150	16.17	22.23	28.74	35.24	41.75	45.06	
10 - 100	18.51	22.32	28.74	35.24	41.75	45.06	

h=	170 mm	170 mm	170 mm	170 mm	170 mm	170 mm	L <sub>s</sub> = 460 mm
12 - 250	Production technically not possible	22.23	28.74	35.24	41.75	45.06	
12 - 200		22.23	28.74	35.24	41.75	45.06	
12 - 150		23.00	28.74	35.24	41.75	45.06	
12 - 100		26.33	31.24	35.80	41.75	45.06	

The verification of the pull-out lengths in construction section 2 must be carried out by the user!  
The tensile force cover must be verified by the user in the pull-out area of the reverse bend connection!  
According to DIN EN 1992-1-1, section 9.3.1.2, paragraph (1), at least half of the field reinforcement of solid slabs must be guided to the support and anchored there!

[www.nevoga.de](http://www.nevoga.de)  
NEVOGA GmbH – Znaimer Str. 4 – D-83395 Freilassing – Telephone: 0049/8654/47310 – Fax: 0049/8654/4731 - 18

Valid until 31/03/2019

Type test

Tested with regard to stability

See test report SLA 130164 of 20/03/2014

LGA Prüfamf für Standsicherheit

der Zweigstelle Landshut

Landshut, 30/03/2014

Result

$V_{Rd}$	[kN/m]	Concrete quality	C30/37
Transverse force vertical - Case e data sheet Reverse bending to EC 2, Fig. 8			
Data sheet reverse bending figure 8 b with transverse force reinforcement			
Good bond conditions according to DIN EN 1992-1-1			
$\sigma_{cd}$	=	0	$b_w = 1.0 \text{ m}$ $C_{nom} = 35 \text{ mm}$
Nevoga Plexus Type B			

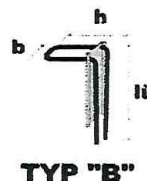

Box width	85 mm	115 mm	145 mm	175 mm	205 mm	225 mm
d=	72.5 mm	102.5 mm	132.5 mm	162.5 mm	192.5 mm	212.5 mm

h=	150 mm	150 mm	150 mm	150 mm	150 mm	150 mm	
Ø – Partition [mm]							
8 - 250	Production technically not possible	70.54	109.19	109.19	109.19	109.19	$L_s = 320 \text{ mm}$
8 - 200		70.54	126.98	136.49	136.49	136.49	
8 - 150		70.54	126.98	181.99	181.99	181.99	
8 - 100		70.54	126.98	183.41	239.85	272.99	

h=	150 mm	150 mm	150 mm	150 mm	150 mm	150 mm	$L_s = 390 \text{ mm}$
10 - 250	Production technically not possible	70.54	126.98	136.49	136.49	136.49	
10 - 200		70.54	126.98	170.62	170.62	170.62	
10 - 150		70.54	126.98	183.41	227.49	227.49	
10 - 100		70.54	126.98	183.41	239.85	227.47	

h=	170 mm	170 mm	170 mm	170 mm	170 mm	170 mm	
12 - 250	Production technically not possible	70.54	126.98	183.41	185.63	185.63	$L_s = 460 \text{ mm}$
12 - 200		70.54	126.98	183.41	232.04	232.04	
12 - 150		70.54	126.98	183.41	239.85	277.47	
12 - 100		70.54	126.98	183.41	239.85	277.47	

The required transverse force reinforcement for vertical stirrups shall be calculated assuming  $\cot \theta = 1$  according to the following equation:  $a_{sw} = V_{ed} / (f_{ywd} * z)$   
 The verification of the pull-out lengths in construction section 2 must be carried out by the user!  
 The tensile force cover must be verified by the user in the pull-out area of the reverse bend connection!  
 According to DIN EN 1992-1-1, section 9.3.1.2, paragraph (1), at least half of the field reinforcement of solid slabs must be guided to the support and anchored there!

[www.nevoga.de](http://www.nevoga.de)  
 NEVOGA GmbH – Znaimer Str. 4 – D-83395 Freilassing – Telephone: 0049/8654/47310 – Fax: 0049/8654/4731 - 18

Valid until 31/03/2019

Type test

Tested with regard to stability  
See test report SLA 130164 of 20/03/2014

LGA Prüfamt für Standsicherheit  
 der Zweigstelle Landshut

Landshut, 30/03/2014

Result

$V_{Rd}$ [kN/m]	Concrete quality	C20/25
Transverse force vertical - Case f data sheet Reverse bending to EC 2, Fig. 8		
Data sheet reverse bending figure 8f		
Good bond conditions according to DIN EN 1992-1-1 (for lower layer)		
$\sigma_{cd} = 0$	$b_w = 1.0 m$	$a_2 \geq 5 \text{ cm}$ and smooth according to chapter 6.2.5 DIN EN 1992-1-1
Nevoga Plexus Type D		



d=	200 mm	240 mm	250 mm	270 mm	290 mm	320 mm	330 mm	350 mm	370 mm	400 mm
----	--------	--------	--------	--------	--------	--------	--------	--------	--------	--------

h=	350 mm	350 mm	350 mm	350 mm	350 mm	350 mm	350 mm	350 mm	350 mm	350 mm	
$\emptyset$ - Partition [mm]											
8 - 250	35.42	39.75	40.81	42.91	44.97	48.00	49.00	50.99	52.95	55.86	L <sub>s</sub> = 320 mm
8 - 200	35.42	39.75	40.81	42.91	44.97	48.00	49.00	50.99	52.95	55.86	
8 - 150	35.42	39.75	40.81	42.91	44.97	48.00	49.00	50.99	52.95	55.86	
8 - 100	35.42	39.75	40.81	42.91	44.97	48.00	49.00	50.99	52.95	55.86	

h=	430 mm	430 mm	430 mm	430 mm	430 mm	430 mm	430 mm	430 mm	430 mm	430 mm	
10 - 250	35.42	39.75	40.81	42.91	44.97	48.00	49.00	50.99	52.95	55.86	L <sub>s</sub> = 390 mm
10 - 200	35.42	39.75	40.81	42.91	44.97	48.00	49.00	50.99	52.95	55.86	
10 - 150	35.42	39.75	40.81	42.91	44.97	48.00	49.00	50.99	52.95	55.86	
10 - 100	35.42	39.75	40.81	42.91	44.97	48.00	49.00	50.99	52.95	55.86	

h=	510 mm	510 mm	510 mm	510 mm	510 mm	510 mm	510 mm	510 mm	510 mm	510 mm	
12 - 250	35.42	39.75	40.81	42.91	44.97	48.00	49.00	50.99	52.95	55.86	L <sub>s</sub> = 460 mm
12 - 200	35.42	39.75	40.81	42.91	44.97	48.00	49.00	50.99	52.95	55.86	
12 - 150	35.42	39.75	40.81	42.91	44.97	48.00	49.00	50.99	52.95	55.86	
12 - 100	35.91	39.75	40.81	42.91	44.97	48.00	49.00	50.99	52.95	55.86	

The verification of the pull-out lengths in construction section 2 must be carried out by the user!  
The tensile force cover must be verified by the user in the pull-out area of the reverse bend connection!  
According to DIN EN 1992-1-1, section 9.3.1.2, paragraph (1), at least half of the field reinforcement of solid slabs must be guided to the support and anchored there!

[www.nevoga.de](http://www.nevoga.de)  
NEVOGA GmbH – Znaimer Str. 4 – D-83395 Freilassing – Telephone: 0049/8654/47310 – Fax: 0049/8654/4731 - 18

Valid until 31/03/2019

Type test

Tested with regard to stability  
See test report SLA 130164 of 20/03/2014

LGA Prüfamt für Standsicherheit  
der Zweigstelle Landshut

Landshut, 30/03/2014

Result

$V_{Rd}$	[kN/m]	Concrete quality	C25/30
Transverse force vertical - Case f data sheet Reverse bending to EC 2, Fig. 8			
Data sheet reverse bending figure 8f			
Good bond conditions according to DIN EN 1992-1-1 (for lower layer)			
$\sigma_{cd} = 0$	$b_w = 1.0m$	$a_2 \geq 5$ cm and smooth according to chapter 6.2.5 DIN EN 1992-1-1	
Nevoga Plexus Type D			

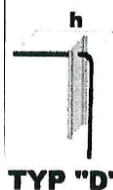

d=	200 mm	240 mm	250 mm	270 mm	290 mm	320 mm	330 mm	350 mm	370 mm	400 mm
----	--------	--------	--------	--------	--------	--------	--------	--------	--------	--------

h=	350 mm	350 mm	350 mm	350 mm	350 mm	350 mm	350 mm	350 mm	350 mm	350 mm	
∅ – Partition [mm]											
8 - 250	39.60	44.45	45.63	47.97	50.27	53.67	54.79	57.01	59.20	62.45	L <sub>s</sub> = 320 mm
8 - 200	39.60	44.45	45.63	47.97	50.27	53.67	54.79	57.01	59.20	62.45	
8 - 150	39.60	44.45	45.63	47.97	50.27	53.67	54.79	57.01	59.20	62.45	
8 - 100	39.60	44.45	45.63	47.97	50.27	53.67	54.79	57.01	59.20	62.45	

h=	430 mm	430 mm	430 mm	430 mm	430 mm	430 mm	430 mm	430 mm	430 mm	430 mm	
10 - 250	39.60	44.45	45.63	47.97	50.27	53.67	54.79	57.01	59.20	62.45	L <sub>s</sub> = 390 mm
10 - 200	39.60	44.45	45.63	47.97	50.27	53.67	54.79	57.01	59.20	62.45	
10 - 150	39.60	44.45	45.63	47.97	50.27	53.67	54.79	57.01	59.20	62.45	
10 - 100	39.60	44.45	45.63	47.97	50.27	53.67	54.79	57.01	59.20	62.45	

h=	510 mm	510 mm	510 mm	510 mm	510 mm	510 mm	510 mm	510 mm	510 mm	510 mm	
12 - 250	39.60	44.45	45.63	47.97	50.27	53.67	54.79	57.01	59.20	62.45	L <sub>s</sub> = 460 mm
12 - 200	39.60	44.45	45.63	47.97	50.27	53.67	54.79	57.01	59.20	62.45	
12 - 150	39.60	44.45	45.63	47.97	50.27	53.67	54.79	57.01	59.20	62.45	
12 - 100	39.60	44.45	45.63	47.97	50.27	53.67	54.79	57.01	59.20	62.45	

The verification of the pull-out lengths in construction section 2 must be carried out by the user!  
The tensile force cover must be verified by the user in the pull-out area of the reverse bend connection!  
According to DIN EN 1992-1-1, section 9.3.1.2, paragraph (1), at least half of the field reinforcement of solid slabs must be guided to the support and anchored there!

[www.nevoga.de](http://www.nevoga.de)  
NEVOGA GmbH – Znaimer Str. 4 – D-83395 Freilassing – Telephone: 0049/8654/47310 – Fax: 0049/8654/4731 - 18

Valid until 31/03/2019

Type test

Tested with regard to stability  
See test report SLA 130164 of 20/03/2014

LGA Prüfamt für Standsicherheit  
der Zweigstelle Landshut

Landshut, 30/03/2014

Result

$V_{Rd}$	[kN/m]	Concrete quality	C30/37
Transverse force vertical - Case f data sheet Reverse bending to EC 2, Fig. 8			
Data sheet reverse bending figure 8f			
Good bond conditions according to DIN EN 1992-1-1 (for lower layer)			
$\sigma_{cd} = 0$	$b_w = 1.0m$	$a_2 \geq 5$ cm and smooth according to chapter 6.2.5 DIN EN 1992-1-1	
Nevoga Plexus Type D			



d=	200 mm	240 mm	250 mm	270 mm	290 mm	320 mm	330 mm	350 mm	370 mm	400 mm
----	--------	--------	--------	--------	--------	--------	--------	--------	--------	--------

h=	350 mm	350 mm	350 mm	350 mm	350 mm	350 mm	350 mm	350 mm	350 mm	350 mm	
$\emptyset$ - Partition [mm]											
8 - 250	43.38	48.69	49.99	52.55	55.07	58.79	60.02	62.45	64.85	68.41	$L_s = 320$ mm
8 - 200	43.38	48.69	49.99	52.55	55.07	58.79	60.02	62.45	64.85	68.41	
8 - 150	43.38	48.69	49.99	52.55	55.07	58.79	60.02	62.45	64.85	68.41	
8 - 100	43.38	48.69	49.99	52.55	55.07	58.79	60.02	62.45	64.85	68.41	

h=	430 mm	430 mm	430 mm	430 mm	430 mm	430 mm	430 mm	430 mm	430 mm	430 mm	
10 - 250	43.38	48.69	49.99	52.55	55.07	58.79	60.02	62.45	64.85	68.41	$L_s = 390$ mm
10 - 200	43.38	48.69	49.99	52.55	55.07	58.79	60.02	62.45	64.85	68.41	
10 - 150	43.38	48.69	49.99	52.55	55.07	58.79	60.02	62.45	64.85	68.41	
10 - 100	43.38	48.69	49.99	52.55	55.07	58.79	60.02	62.45	64.85	68.41	

h=	510 mm	510 mm	510 mm	510 mm	510 mm	510 mm	510 mm	510 mm	510 mm	510 mm	
12 - 250	43.38	48.69	49.99	52.55	55.07	58.79	60.02	62.45	64.85	68.41	$L_s = 460$ mm
12 - 200	43.38	48.69	49.99	52.55	55.07	58.79	60.02	62.45	64.85	68.41	
12 - 150	43.38	48.69	49.99	52.55	55.07	58.79	60.02	62.45	64.85	68.41	
12 - 100	43.38	48.69	49.99	52.55	55.07	58.79	60.02	62.45	64.85	68.41	

The verification of the pull-out lengths in construction section 2 must be carried out by the user!  
The tensile force cover must be verified by the user in the pull-out area of the reverse bend connection!  
According to DIN EN 1992-1-1, section 9.3.1.2, paragraph (1), at least half of the field reinforcement of solid slabs must be guided to the support and anchored there!

[www.nevoga.de](http://www.nevoga.de)  
NEVOGA GmbH – Znaimer Str. 4 – D-83395 Freilassing – Telephone: 0049/8654/47310 – Fax: 0049/8654/4731 - 18

Valid until 31/03/2019

Type test

Tested with regard to stability  
See test report SLA 130164 of 20/03/2014

LGA Prüfamt für Standsicherheit  
der Zweigstelle Landshut

Landshut, 30/03/2014