

MOUNTING INSTRUCTIONS

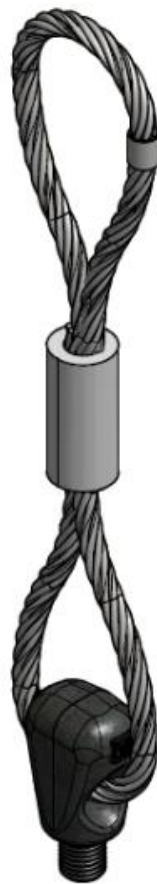

1D - LIFTING SYSTEMS | **THS1 – THREADED LIFTING SLING**



THS1 – APPLICATIONS

SCREWING DETAILS

Ensure that the thread is fully bottomed out in the socket before lifting. A back rotation up to a maximum 90° is allowed to adjust the loop direction towards the load. **No gaps are permitted between the concrete element and the body of the lifting system: the thread must be fully threaded inside the socket.**

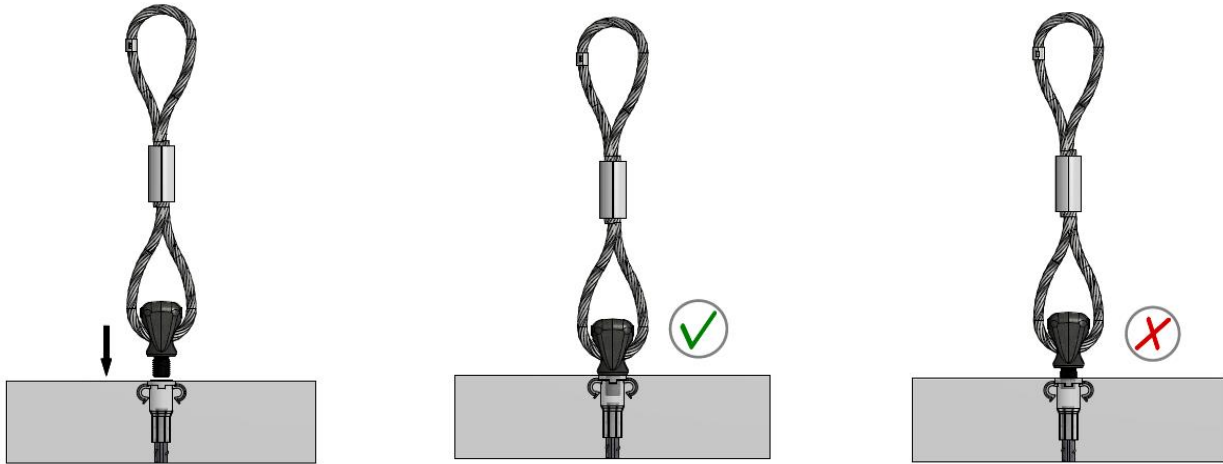

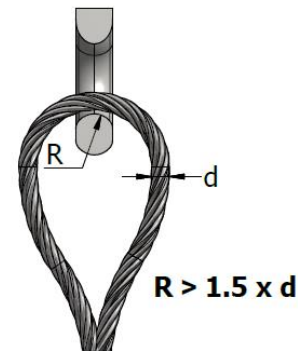
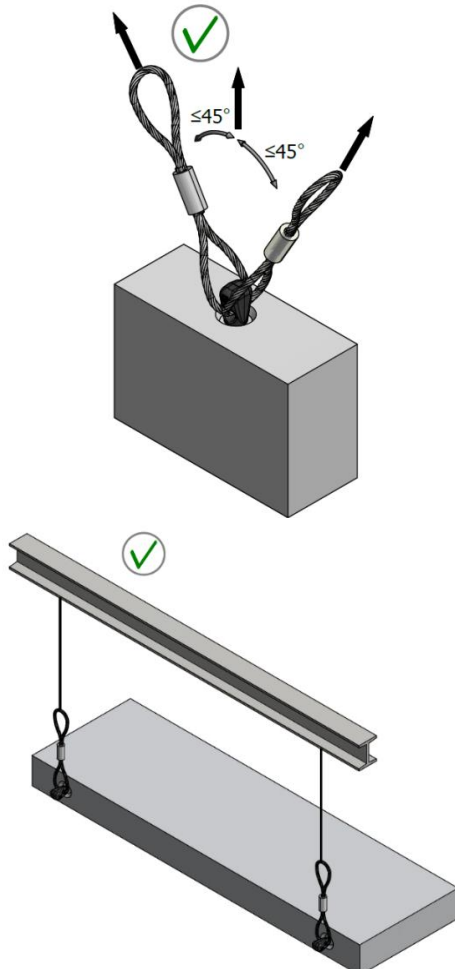

The preferred option is the vertical lift. Normally the angle of lift (β) should not be greater than 30°. **Pulling back towards the unit is not permitted.**

ADMISSIBLE LOAD DIRECTION

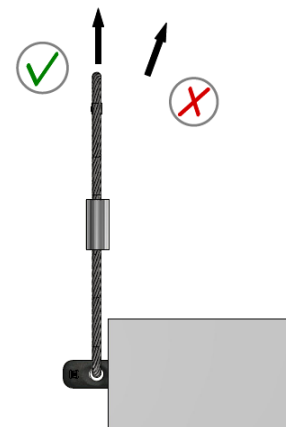

Note: Minimum radius of the crane hook for the wire loop must be $R > 1.5 \times d$

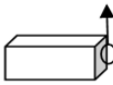
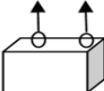
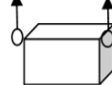
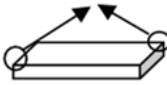
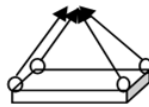

Number of pieces	1	1	2	2	2	2	3 or 4	3 or 4
Type of attachment								
Angle of inclination	0°	90°	0°	90°	0° - 45°	45° - 60°	0° - 45°	45° - 60°
THS1-M/Rd	WLL group	Axial load	Load group	Axial load	Load group	Axial load	Load group	Axial load
	[kN]	[kN]	[kN]	[kN]	[kN]	[kN]	[kN]	[kN]
THS1-M/Rd12	13	6.5	26	13	9.1	6.5	13	9.1
THS1-M/Rd16	25	12.5	50	25	17.5	12.5	25	17.5
THS1-M/Rd20	40	20.0	80	40	28.0	20.0	40	28.0
THS1-M/Rd24	50	25.0	100	50	35.0	25.0	50	35.0
THS1-M/Rd30	75	37.5	150	75	52.5	37.5	75	52.5
THS1-M/Rd36	100	50.0	200	100	70.0	50.0	100	70.0
THS1-M/Rd42	125	62.5	250	125	84.0	62.5	125	84.0
THS1-M/Rd52	150	75.0	300	150	105.0	75.0	150	105.0

GENERAL GUIDANCE FOR LIFTING WITH TERWA THL, THS1 and THS3

Ensure that the concrete has MPa strength of at least 15 before beginning lifting.

The first choice for most lifting applications is the lifting socket with waved rebar tail (TGK, TGL). For positioning the inserts, always check the permitted edge distances and spacing between inserts.

We recommend restricting the lift angle to a maximum of 30° when an angled lift is necessary.

To choose the proper lifting system, take into consideration how frequently the precast unit is going to be lifted.

The cast-in threaded elements (anchors or fixing inserts) can be flush or recessed for corrosion protection.

This recess is filled with fine concrete after use.

All the lifting systems are tested before delivery under a test load three times the working load (individual test for THS1 and THS3, test for every batch of THL and TIL).

CONTACT



TERWA is the global supplier for precast and construction solutions with multiple offices around the world. With all our staff, partners and agents, we are happy to provide all construction and precast companies who work in the building industry with full service and 100% support.

TERWA CONSTRUCTION GROUP

Terwa Construction Netherlands (HQ)

Global Sales & Distribution
 Kamerlingh Onneslaan 1-3
 3401 MZ IJsselstein
 The Netherlands
T +31-(0)30 699 13 29
F +31-(0)30 220 10 77
E info@terwa.com

Terwa Construction Central East Europe

Sales & Distribution
 Strada Sânzieni
 507075 Ghimbav
 Romania
T +40 372 611 576
E info@terwa.com

Terwa Construction Poland

Sales & Distribution
 Ul. Cicha 5 lok. 4
 00-353 Warszawa
 Poland
E info@terwa.com

Terwa Construction India & Middle East

Sales & Distribution
 India
T +91 89 687 000 41
E info@terwa.com

Terwa Construction China

Sales & distribution
 5F 504, No. 101 Chuanchang road
 PRC, 200032, Shanghai
 China
E info@terwa.com

ALL SPECIFICATIONS CAN BE CHANGED WITHOUT PREVIOUS NOTICE.

DISCLAIMER

Terwa B.V. is not liable for deviations due to wear of the products it has delivered. Neither is Terwa B.V. liable for damage due to inaccurate and/or improper handling and use of the products it has delivered and/or use of same for purposes other than those intended.

Terwa B.V.'s responsibility is furthermore limited in accordance with article 13 of the "Metaalunie" conditions, which are applicable for all Terwa B.V. deliveries. The user is responsible for ensuring compliance with all applicable copyright laws. Without limiting the rights under copyright, no part of this documentation may be reproduced, stored in or introduced into a retrieval system, or transmitted in any form or by any means (electronic, mechanical, photocopying, recording, or otherwise), or for any purpose, without the express written permission of Terwa B.V.